

1. Device Name TCXO
2. Model Name DSB221SDN
3. Nominal Frequency 38.400 MHz
4. Mass 0.02g max.
5. Absolute Maximum Ratings

	Item	Symbol	Rating	unit
1	Supply Voltage	V _{CC}	-0.3~+4.6	V
2	Storage Temperature Range	T _{STG}	-40~+85	°C

6. Recommended Operating Conditions

	Item	Symbol	min.	typ.	max.	unit
1	Supply Voltage	V _{CC}	+1.71	+1.8	+1.89	V
2	Load Impedance (resistance part) (parallel capacitance)	LOAD_R	9	10	11	kΩ
		LOAD_C	9	10	11	pF
3	Operating Temperature Range	T _{OPR}	-40	-	+85	°C

7. Electrical Characteristics

(T_A=-40~+85°C, LOAD_R//C=10kΩ//10pF, V_{CC}=+1.8V, unless otherwise noted)

	Item	Conditions	Limits			unit	Notes
			min.	typ	max.		
1	Current Consumption		-	-	+2.0	mA	
2	Output Level		0.8	-	-	V _{P-P}	1
3	Symmetry	GND level (DC cut)	40/60	-	60/40	%	
4	Harmonics		-	-	-5	dBc	
5	Frequency Stability 1.Tolerance	At Shipping Ref. to nominal frequency	-	-	±0.5	ppm	2
		After 2 times reflow Ref. to nominal frequency	-	-	±1.0	ppm	2,3
	2.vs Temperature	T _A =-40~+85°C Ref. to frequency (T _A =+25°C)	-	-	±0.5	ppm	
	3.vs Supply Voltage	V _{CC} =+1.8V±5%	-	-	±0.2	ppm	
	4.vs Load Variation	LOAD_R//C=(10kΩ//10pF)±10%	-	-	±0.2	ppm	
	5.vs Aging	T _A =Room ambient	-	-	±0.5	ppm/year	
6	Start Up Time	@90% of final Vout level	-	-	2.0	ms	
7	SSB Phase Noise	Relative to f0 level offset 1kHz	-	-	-135	dBc/Hz	

Notes

1. Clipped sine wave (DC-coupled)
2. T_A=+25°C
3. Please leave after reflow in 2h or more at room ambient.
4. 1 Frequency reading for every 2°C

TITLE DSB221SDN TYPE SPECIFICATION		Remark T16-0207		
Date 2016/03/28	Spec. No. 1XXB38400MZA		Rev. -	Page 1/2

8. Outline, Pin Connections

Outline

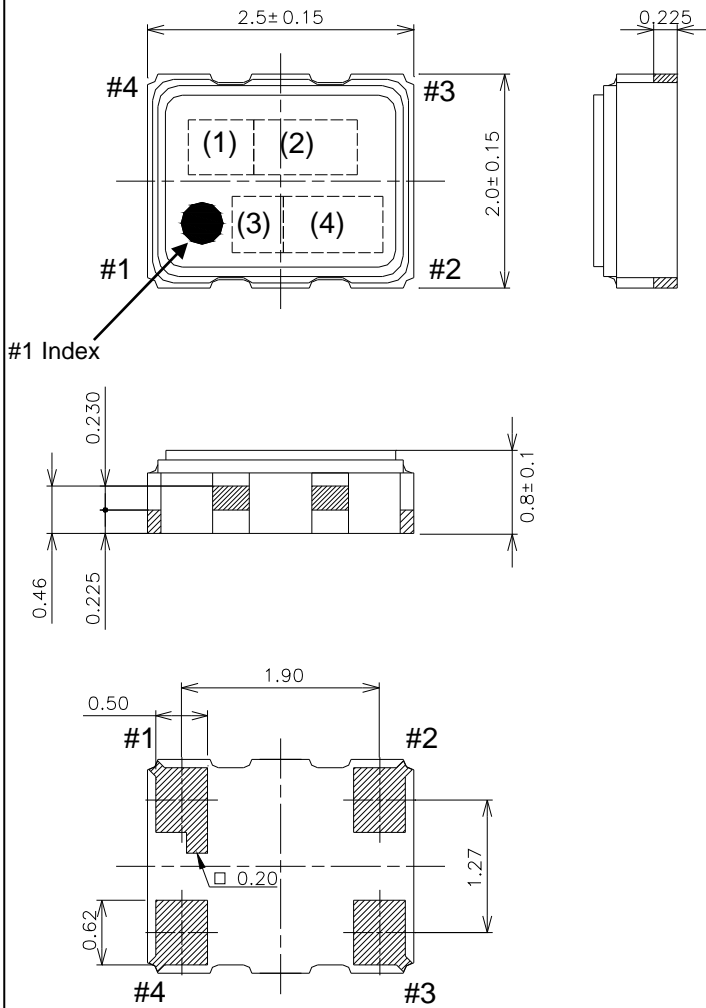

Pin Connections

Pin No.	Connection
#1	GND
#2	GND
#3	Output
#4	V _{CC}

Marking

(1) Model code	BN
(2) Frequency	38.4 (MHz, 3digits)
(3) Logo	D
(4) Date code	Year (1digit) +Week (2digits) e.g.2016/1/1 → 601

unit: mm

Dimensional Tolerance: ±0.15

(Unless otherwise noted)

9. Measurement Circuit

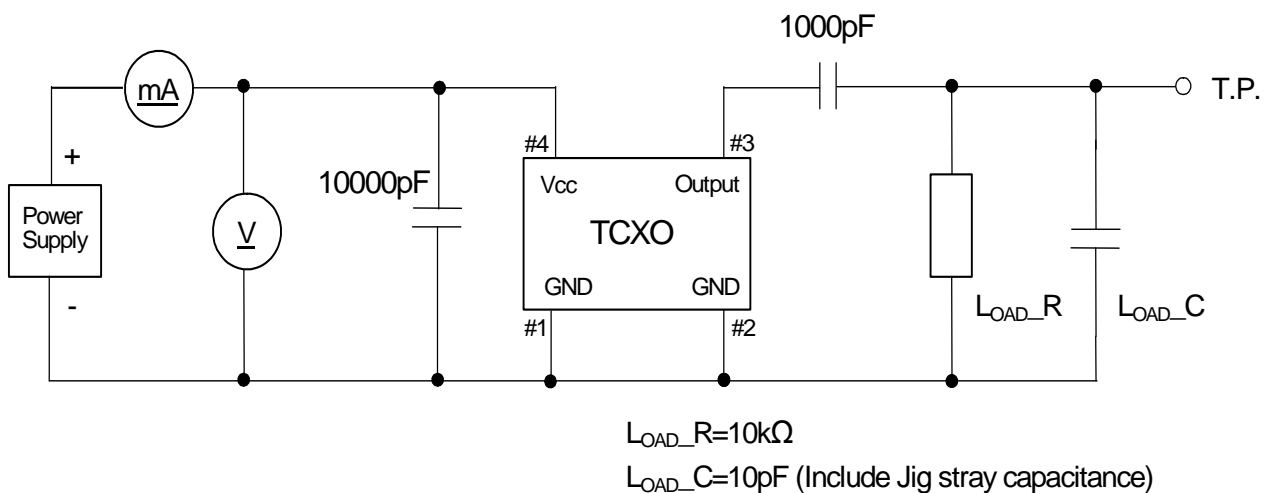

TITLE
DSB221SDN TYPE SPECIFICATION

Remark
T16-0207

Date
2016/03/28

Spec. No.
1XXB38400MZA

Rev.
-

Page
2/2