



# RUBIK Pi 3 Datasheet

**Revision: V1.0**

**Date: Dec 09, 2024**



## Revision History

Revision	Date	Description
1.0	Dec 09, 2024	Initial release.



# Table of Contents

Chapter 1. Overview .....	1
Chapter 2. Features .....	3
2.1. System block diagram .....	3
2.2. Component locations .....	4
2.3. Electrical characteristics .....	5
2.3.1. Power supply requirements .....	5
2.3.2. Output power requirements .....	6
2.4. Mechanical specification.....	7
Chapter 3. Expansion Connections .....	8
3.1. 40-pin LS connector .....	8
3.2. HDMI connector.....	9
3.3. Ethernet connector .....	9
3.4. USB connector .....	10
3.4.1. USB3.1 Gen1 Type-C .....	10
3.4.2. USB3.0 Type-A .....	10
3.4.3. USB2.0 Type-A .....	10
3.5. 3.5mm audio connector .....	11
3.6. Camera connector .....	11
3.7. M.2 connector.....	13
3.8. Wi-Fi .....	14
3.9. Bluetooth .....	15
3.10. Fan connector.....	15
3.11. RTC battery connector.....	16
3.12. Micro USB to UART for debug .....	16
3.13. Buttons .....	17
3.13.1. Power on button .....	17
3.13.2. EDL button .....	17
3.14. LED .....	17
3.14.1. Power indicator LED .....	17
3.14.2. RGB LED .....	18
Chapter 4. Precautions .....	19
4.1. Operating environment .....	19
4.2. ESD prevention .....	19
4.3. Warning .....	19
4.4. Safety instructions .....	19

# Chapter 1. Overview

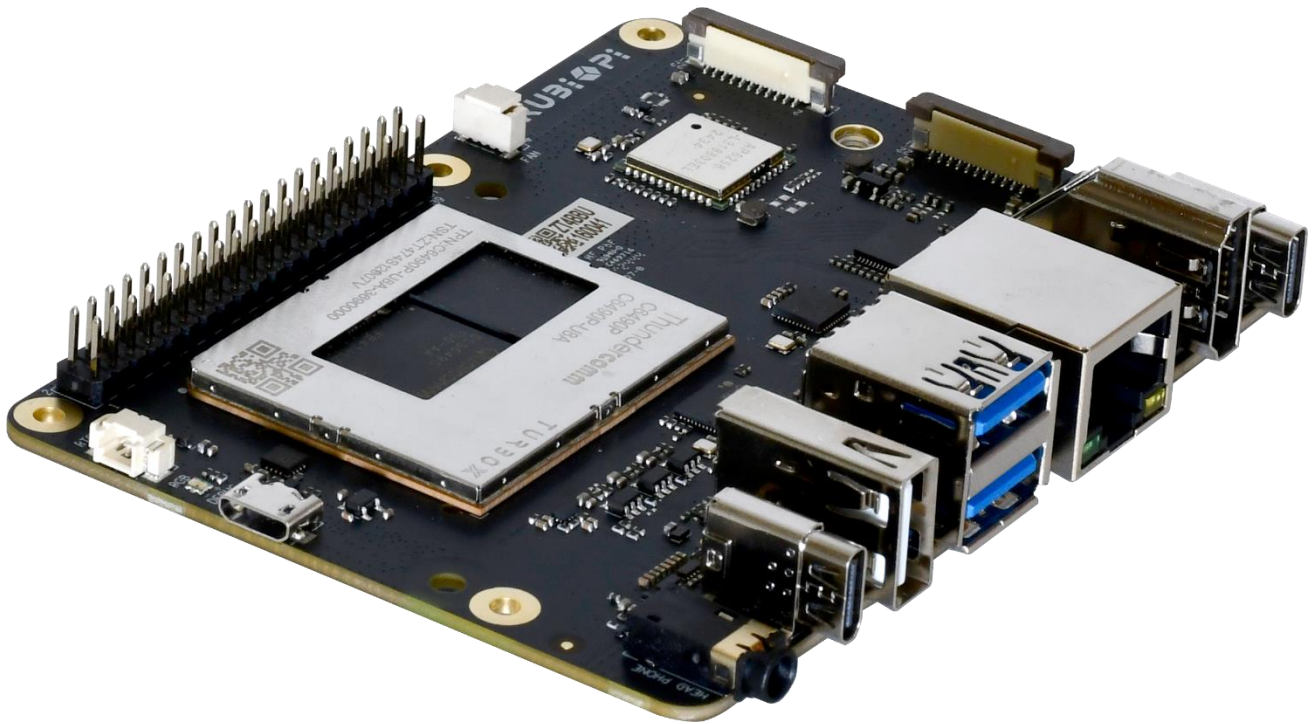

Category	RUBIK Pi 3 Feature
Platform	Qualcomm® QCS6490 RAM 8 GB LPDDR4x ROM 128 GB UFS2.2
Video	1 x HDMI 1.4 output (up to 4K 30 Hz) 1 x DP over USB Type-C (up to 4K 60 Hz) 2 x camera connector (4-lane MIPI CSI D-PHY)
Audio	1 x 3.5mm headphone jack
Connectivity	1 x USB Type-C (USB3.1 Gen 1) 2 x USB Type-A (USB3.0) 1 x USB Type-A (USB2.0) 1 x 1000M Ethernet (RJ45) 1 x UART for debug (over Micro USB) 1 x M.2 Key M connector (PCIe3.0 2-lane) 40-pin LS connector supporting various interface options: <ul style="list-style-type: none"> <li>• Up to 28 x GPIO</li> <li>• Up to 2 x I2C</li> <li>• Up to 3 x UART</li> <li>• Up to 3 x SPI</li> <li>• 1 x I2S (PCM)</li> <li>• 1 x PWM channel</li> </ul>



Category	RUBIK Pi 3 Feature
Others	1 x Power on button 1 x EDL button 1 x RGB LED 2-pin RTC battery connector 4-pin PWM fan connector
Wireless connection	Wi-Fi: IEEE 802.11 a/b/g/n/ac Wi-Fi Bluetooth: BT 5.2 On-board PCB antenna
Power supply	Power Delivery over Type-C, 12V 3A
Operating environment	Operating temperature: 0 – 70°C
Dimensions	100mm x 75mm
OS support	Android 13 Qualcomm Linux *Canonical Ubuntu for Qualcomm platforms

\*Planning.

# Chapter 2. Features

## 2.1. System block diagram

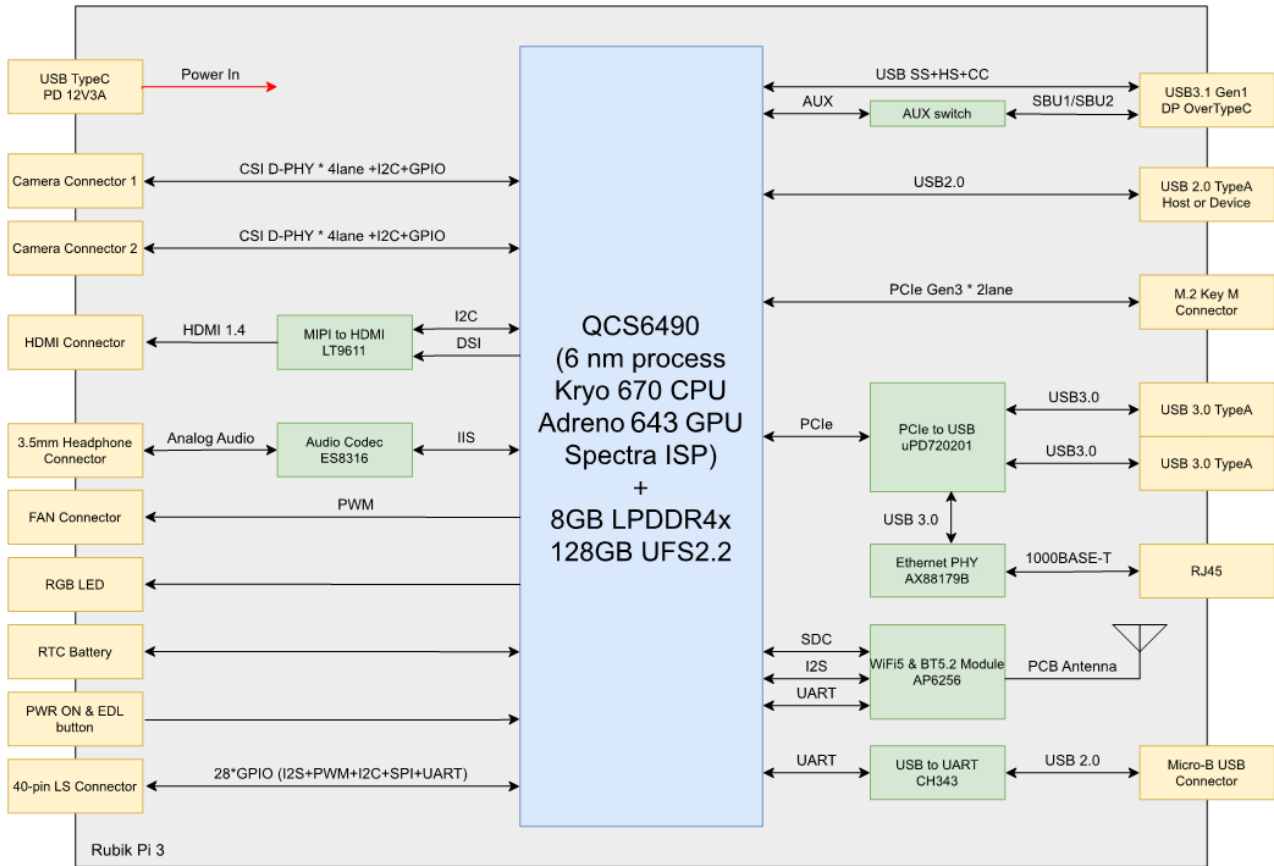

Figure 2-1. RUBIK Pi 3 System Block

## 2.2. Component locations

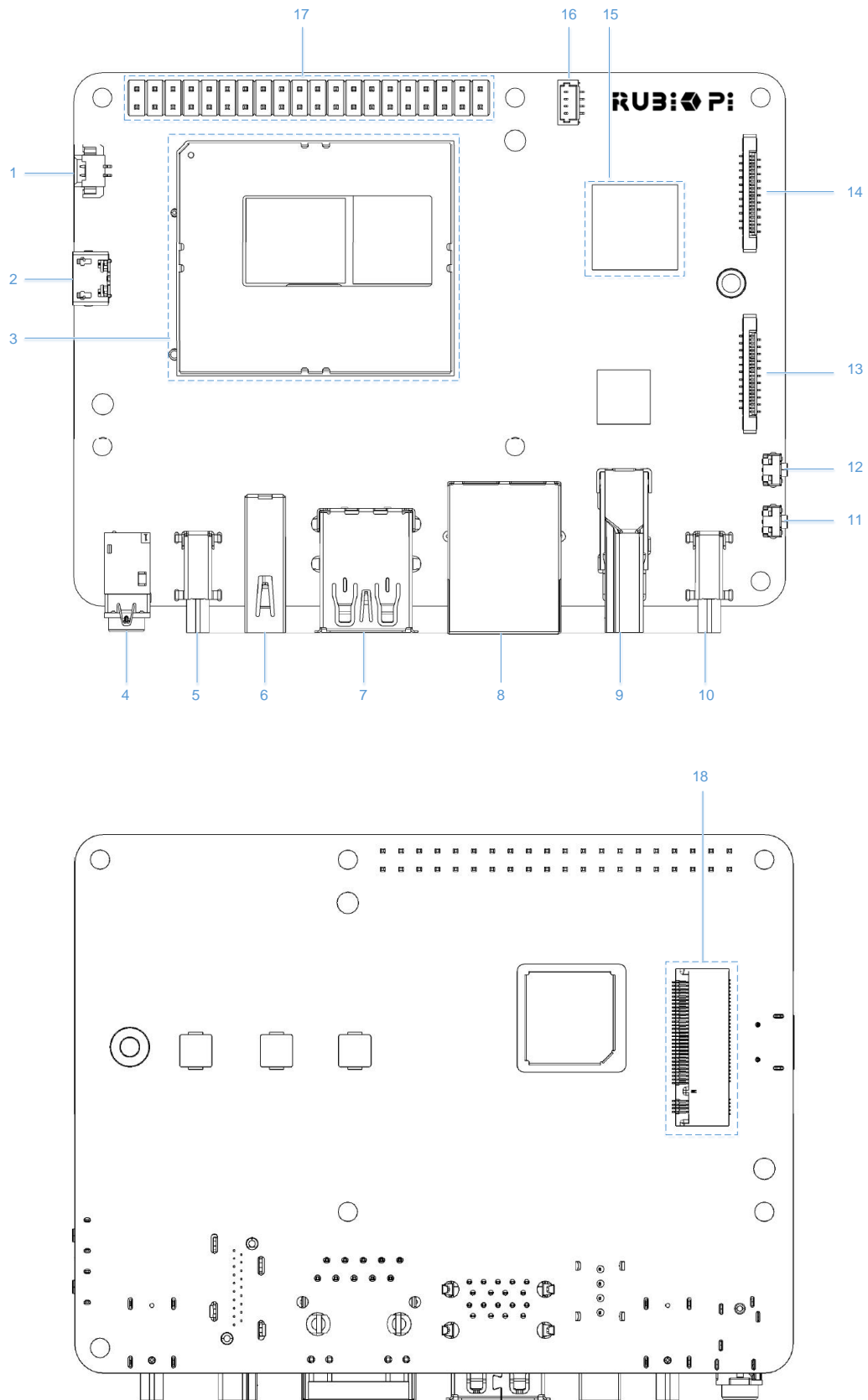

Figure 2-2. Locations of Major Components

Table 2-1. Interface list

No.	Interface	No.	Interface
1	RTC battery connector	10	Power Delivery over Type-C
2	Micro USB (UART debug)	11	Power on button
3	QCS6490 module	12	EDL button
4	3.5mm headphone jack	13	Camera connector 1
5	USB Type-C with DP (USB3.1)	14	Camera connector 2
6	USB Type-A (USB2.0)	15	Wi-Fi/BT module
7	2 x USB Type-A (USB3.0)	16	Fan connector
8	1000M Ethernet	17	40-pin LS connector
9	HDMI OUT	18	M.2 Key M connector

## 2.3. Electrical characteristics

### 2.3.1. Power supply requirements

Rubik Pi 3 supports PD 3.0 power input. A Type-C 12V 3A power adapter compliant with PD3.0 is recommended for input power. The 27W power adapter used by Raspberry Pi 5 is also applicable to RUBIK Pi 3.

The power indicator LED (in yellow green) will turn on if the power adapter meets requirements and power negotiation succeeds. If the adapter does not meet requirements, the LED will remain off and the device will not boot.

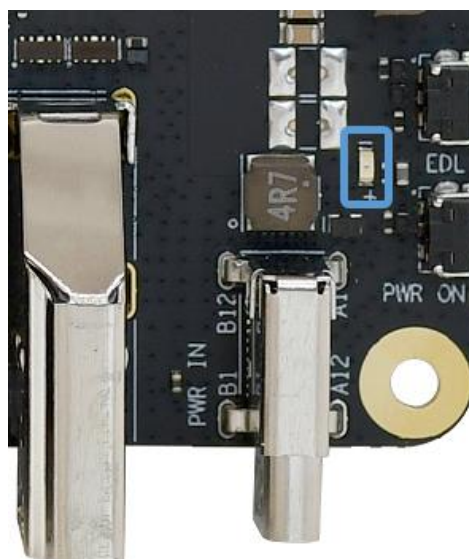

Figure 2-3. Power Indicator





## 2.3.2. Output power requirements

The following table lists the maximum current output from each connector with a 12V 3A power supply.

Table 2-2. Maximum current output from each connector

Connector	Output Voltage	Max. Output Current	Remarks
USB3.0 Type-A - 1	5V	1.5A	The total current simultaneously output from the three USB ports cannot exceed 3A.
USB3.0 Type-A - 2	5V	1.5A	
USB2.0 Type-A	5V	1.5A	
40 Pin GPIO	5V	1A	
	3.3V	1A	
HDMI	5V	100mA	
M.2 Key M	3.3V	1A	
Camera 1	3.3V	300mA	
Camera 2	3.3V	300mA	

An output current exceeding the maximum threshold will trigger output power protection or a system restart.

It is not recommended to use the USB port of RUBIK Pi 3 to supply power to USB devices with high power consumption, such as USB fans, speakers, or displays.



## 2.4. Mechanical specification

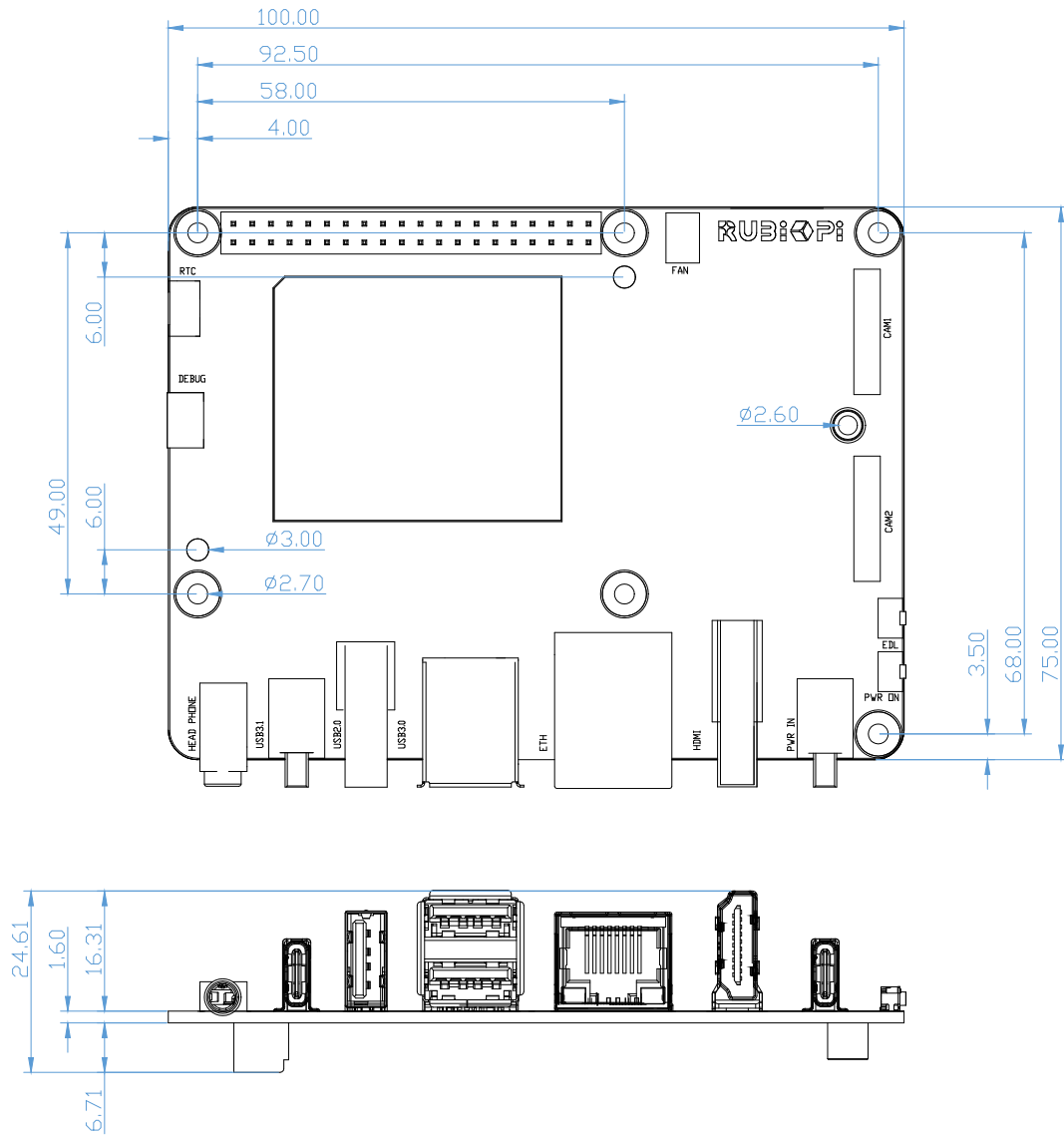

Figure 2-4. RUBIK Pi 3 Dimensions

\*All dimensions are in millimeters.



## Chapter 3. Expansion Connections

### 3.1. 40-pin LS connector

RUBIK Pi 3 provides 28 GPIOs. By default, 2 x I2C, 1 x UART, 1 x SPI, 1 x I2S, 1 x PWM IO, and 9 GPIOs are configured.

Table 3-1. Pin definitions of the 40-pin LS connector

Alternate Function	QUP	GPIO	No.	No.	GPIO	QUP	Alternate Function
VCC3V3			1	2	VCC5V		
I2C1_SDA	QUP0_L0[1]	GPIO_4	3	4	VCC5V		
I2C1_SCL	QUP0_L1[1]	GPIO_5	5	6	GND		
I2S_MCLK		GPIO_105	7	8	GPIO_10	QUP0_L2[2]	UART_TXD
GND			9	10	GPIO_11	QUP0_L3[2]	UART_RXD
UART_CTS	QUP0_L0[2]	GPIO_8	11	12	GPIO_101		I2S_CLK
	QUP0_L0[6]	GPIO_24	13	14	GND		
	QUP0_L1[6]	GPIO_25	15	16	GPIO_26	QUP0_L2[6]	
VCC3V3			17	18	GPIO_27	QUP0_L3[6]	
SPI_MOSI	QUP1_L1[4]	GPIO_49	19	20	GND		
SPI_MISO	QUP1_L0[4]	GPIO_48	21	22	GPIO_44	QUP1_L0[3]	
SPI_SCLK	QUP1_L2[4]	GPIO_50	23	24	GPIO_51	QUP1_L3[4]	SPI_CS0
GND			25	26	GPIO_55	QUP1_L4[4]	SPI_CS1
I2C2_SDA	QUP0_L0[3]	GPIO_12	27	28	GPIO_13	QUP0_L1[3]	I2C2_SCL
	QUP1_L0[0]	GPIO_32	29	30	GND		
	QUP1_L1[0]	GPIO_33	31	32	PM_C_GPIO_09		PWM
	QUP1_L2[0]	GPIO_34	33	34	GND		
I2S_WS		GPIO_103	35	36	GPIO_9	QUP0_L1[2]	UART_RTS
	QUP1_L3[0]	GPIO_35	37	38	GPIO_102		I2S_DIN
GND			39	40	GPIO_104		I2S_DOUT

The level of all GPIOs is 3.3V. The I2C GPIOs (GPIO 4, 5, 12, 13) are in open-drain output mode with 4.7 k $\Omega$  pull-up resistors. The other GPIOs are in push-pull output mode, and the external pull-up or pull-down resistors of the connected signals cannot be less than 50 k $\Omega$  due to the limitations of the on-board level shifter IC.

The GPIOs belonging to the same QUP group can be flexibly configured as UART or SPI. For details, refer to the user manual.

The 2.54mm pitch 40-pin LS connector is compatible with most Raspberry Pi expansion boards.

## 3.2. HDMI connector

RUBIK Pi 3 comes with a standard-sized HDMI connector that is compatible with HDMI 1.4. This connector supports a maximum output of 4K 30 Hz. Additionally, it provides the CEC functionality, as well as 5V DDC and HPD interfaces.

## 3.3. Ethernet connector

RUBIK Pi 3 is equipped with a standard RJ45 connector that includes Link and Active indicator LEDs. This connector supports high-speed communication of up to 1000 Mbps in full duplex mode.



Figure 3-1. Link and Active Indicators

## 3.4. USB connector

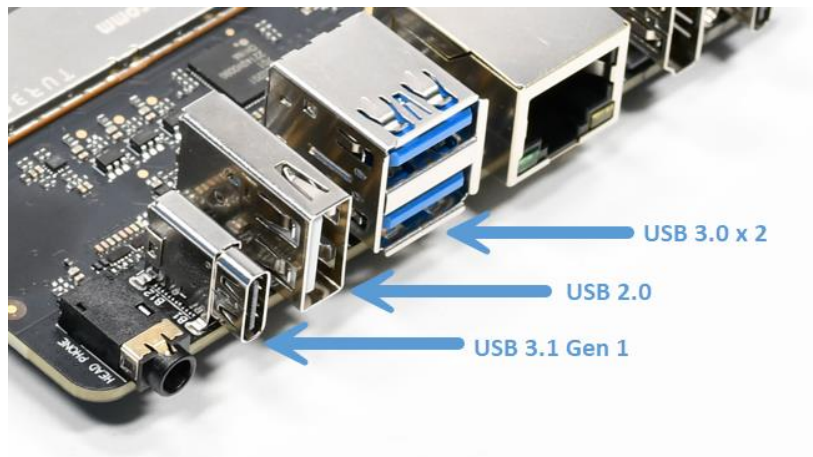

Figure 3-2. USB Ports

### 3.4.1. USB3.1 Gen1 Type-C

RUBIK Pi 3 incorporates a USB3.1 Gen1 Type-C port that supports Type-C with DisplayPort v1.4. The port allows for a maximum output of 4K 60 Hz when used with a Type-C to DP cable and supports read/write operations at speeds of up to 5 Gbps.

By default, this port is used for ADB debugging.

### 3.4.2. USB3.0 Type-A

RUBIK Pi 3 features two standard USB 3.0 Type-A ports, each supporting read and write operations at speeds of up to 4 Gbps.

The USB 3.0 Type-A port can operate in host mode only. Each individual port has a maximum output capacity of 5V 1.5A. The power output of each port can be individually controlled.

### 3.4.3. USB2.0 Type-A

RUBIK Pi 3 is equipped with a standard USB2.0 Type-A port which supports read and write operations at speeds of up to 480 Mbps. This port works in host mode by default and can be switched to device mode and used as an ADB interface by using software. The maximum output capacity of this port is 5V 1.5A, while the total output of all three USB Type-A ports is 3A. The power output of this port can be individually controlled.

### 3.5. 3.5mm audio connector

The 3.5mm audio connector is designed according to CITA standard and supports left and right channels and microphone inputs.

The following figure shows the rings on the plug. From right to left, they are: 1-left channel, 2-right channel, 3-ground, 4-microphone.



Figure 3-3. Headphone Plug

Table 3-2. Pin definitions of the 3.5mm audio connector

Pin No.	Pin Name
1	Left
2	Right
3	GND
4	Mic

### 3.6. Camera connector

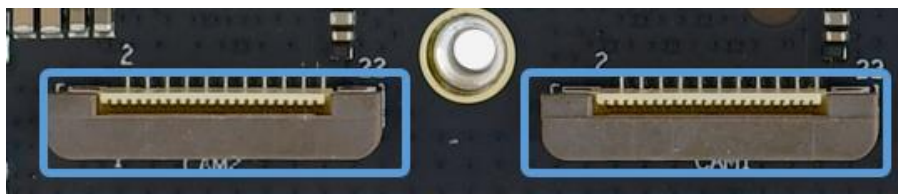

Figure 3-4. Camera Connectors

RUBIK Pi 3 provides two 22-pin camera connectors. Each connector supports 4-lane MIPI CSI D-PHY and provides one I2C and two control GPIOs. The GPIO level is 3.3V, where the I2C signal is in open-drain mode with pull-up resistors. The pitch of the connector is 0.5mm and the connector is pin-to-pin compatible with Raspberry Pi 5 cameras.



Cameras that have been successfully debugged:

- Raspberry Pi HQ Camera (IMX 477)
- Raspberry Pi Camera Module 2 (IMX 219)
- Raspberry Pi Camera Module 3 (IMX 708)

Table 3-3. Pin definitions of the camera connectors

Camera Connector 1		Camera Connector 2	
Pin Name	Pin No.	Pin No.	Pin Name
GND	1	1	GND
CSI0_LN0_M	2	2	CSI1_LN0_M
CSI0_LN0_P	3	3	CSI1_LN0_P
GND	4	4	GND
CSI0_LN1_M	5	5	CSI1_LN1_M
CSI0_LN1_P	6	6	CSI1_LN1_P
GND	7	7	GND
CSI0_CLK_M	8	8	CSI1_CLK_M
CSI0_CLK_P	9	9	CSI1_CLK_P
GND	10	10	GND
CSI0_LN2_M	11	11	CSI1_LN2_M
CSI0_LN2_P	12	12	CSI1_LN2_P
GND	13	13	GND
CSI0_LN3_M	14	14	CSI1_LN3_M
CSI0_LN3_P	15	15	CSI1_LN3_P
GND	16	16	GND
CAMERA1_PWR_EN(GPIO_57)	17	17	CAMERA2_PWR_EN(GPIO_58)
CAMERA1_GPIO(GPIO_18)	18	18	CAMERA2_GPIO(GPIO_19)
GND	19	19	GND
CAMERA1_I2C_SCL(GPIO_74)	20	20	CAMERA2_I2C_SCL(GPIO_70)
CAMERA1_I2C_SDA(GPIO_73)	21	21	CAMERA2_I2C_SDA(GPIO_69)
VCC3V3_OUT	22	22	VCC3V3_OUT

### 3.7. M.2 connector

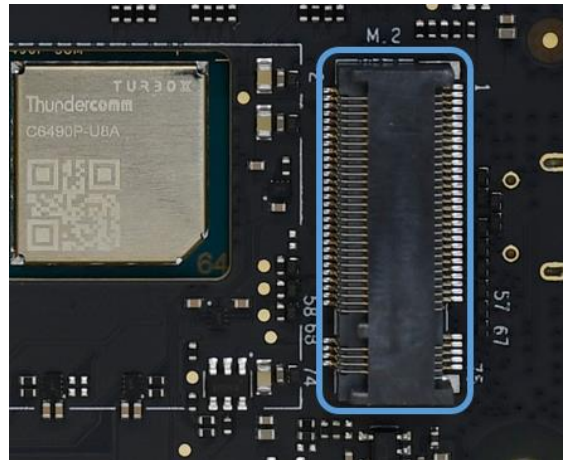

Figure 3-5. M.2 Connector

RUBIK Pi 3 provides an M.2 slot for NVMe storage, which can be used to install 2280-sized SSD hard drives. The M.2 Key M slot supports PCIe Gen3 x2 and can deliver an output of up to 3.3V 2A. The switch of the M.2 connector can be individually controlled.

Table 3-4. Pin definitions of the M.2 connector

Pin Name	Pin No.	Pin No.	Pin Name
GND	1	2	VCC3V3_OUT
GND	3	4	VCC3V3_OUT
NC	5	6	NC
NC	7	8	NC
GND	9	10	NC
NC	11	12	VCC3V3_OUT
NC	13	14	VCC3V3_OUT
GND	15	16	VCC3V3_OUT
NC	17	18	VCC3V3_OUT
NC	19	20	NC
GND	21	22	NC
NC	23	24	NC
NC	25	26	NC
GND	27	28	NC





Pin Name	Pin No.	Pin No.	Pin Name
PCIE1_RX1_M	29	30	NC
PCIE1_RX1_P	31	32	NC
GND	33	34	NC
PCIE1_TX1_M	35	36	NC
PCIE1_TX1_P	37	38	NC
GND	39	40	NC
PCIE1_RX0_M	41	42	NC
PCIE1_RX0_P	43	44	NC
GND	45	46	NC
PCIE1_TX0_M	47	48	NC
PCIE1_TX0_P	49	50	PCIE_RESET_N <sup>(1)</sup>
GND	51	52	PCIE_CLK_REQ_N <sup>(1)</sup>
PCIE1_REFCLK_M	53	54	PCIE_WAKE_N <sup>(1)</sup>
PCIE1_REFCLK_P	55	56	NC
GND	57	58	NC
...	...	...	...
NC	67	68	NC
NC	69	70	VCC3V3_OUT
GND	71	72	VCC3V3_OUT
GND	73	74	VCC3V3_OUT
GND	75		

(1). The level of the PCIe control IOs are 3.3V.

### 3.8. Wi-Fi

RUBIK Pi 3 integrates the on-board wireless communication module that supports IEEE 802.11 a/b/g/n/ac Wi-Fi. The on-board PCB antenna is provided, eliminating the need for additional antennas.

### 3.9. Bluetooth

The on-board wireless communication module of RUBIK Pi 3 also provides the BT5.2 function for Bluetooth data transfer and Bluetooth audio applications. The Bluetooth shares the PCB antenna with Wi-Fi, eliminating the need for additional antennas.

### 3.10. Fan connector



Figure 3-6. Fan Connector

The fan connector of RUBIK Pi 3 is a 4-pin 1mm pitch connector which is suitable for 5V fans whose maximum rated current is smaller than 200 mA. Its pin definition and board mounting holes are compatible with the official Raspberry Pi 5 fan. The fan connector supports PWM control.

Table 3-5. Pin definitions of the fan connector

Pin No.	Pin Name
1	NC
2	GND
3	PWM_OUT <sup>(1)</sup>
4	VCC5V_OUT

(1). The level of PWM\_OUT is 5V.

### 3.11. RTC battery connector



Figure 3-7. RTC Battery Connector

RUBIK Pi 3 includes a 2-pin 1.25mm pitch RTC battery connector, compatible only with 3V coin cell batteries. The voltage range for normal operation is 2V – 3.25V.

Table 3-6. Pin definitions of the RTC battery connector

Pin No.	Pin Name
1	VCC3V_IN
2	GND

### 3.12. Micro USB to UART for debug



Figure 3-8. Micro USB

RUBIK Pi 3 incorporates the CH343, a USB to UART TTL bridge IC made by WinChipHead (WCH). UART logs from the SoC can be obtained through connecting the device to a computer via micro USB. The default UART setting is 115200 baud rate, 8 data bits, 1 stop bit, and no parity.

Download the CH343 driver at the official website: [Driver Nanjing Qinheng Microelectronics](#).

## 3.13. Buttons

### 3.13.1. Power on button

Plug in the power supply and press the **[PWR ON]** button once to boot up the device. If the indicator light flashes once, it indicates that the device has powered on successfully and is starting to operate.

### 3.13.2. EDL button

The EDL button stands for Emergency Download (EDL) button. Plug in the power supply. Press and hold both the **[PWR ON]** button and **[EDL]** button for more than 3s to make the device enter EDL mode (9008).

## 3.14. LED

### 3.14.1. Power indicator LED

The indicator LED lights steadily in yellow-green when a compliant (12V 3A, PD-supported) power supply is connected, indicating that the device is ready.

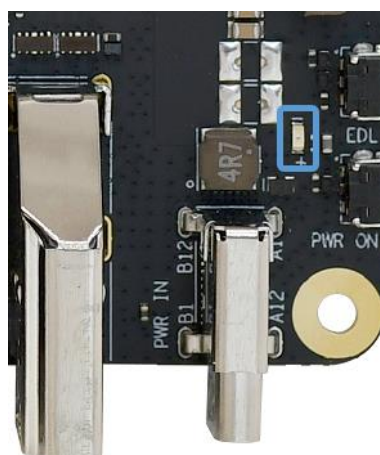

Figure 3-9. Power Indicator LED

### 3.14.2. RGB LED

RUBIK Pi 3 is equipped with an on-board RGB LED that supports PWM dimming.



*Figure 3-10. RGB LED*



## Chapter 4. Precautions

### 4.1. Operating environment

The ambient operating temperature range for RUBIK Pi 3 is 0 – 70°C. While using RUBIK Pi 3, please closely monitor the CPU temperature and take appropriate cooling measures to ensure it stays below 85°C. This will help prevent issues like performance degradation or throttling that could negatively affect the user experience.

### 4.2. ESD prevention

Prevent electrostatic discharge (ESD) and avoid touching any components on the board under any circumstances.

### 4.3. Warning

Any external power supply used with RUBIK Pi 3 must comply with the relevant regulations and standards of the country in which it is used. The power supply should provide at least 12V DC at 3A.

### 4.4. Safety instructions

- This product should not be overclocked.
- Do not operate this product in water or humid environments.
- Do not place this product on conductive surfaces.
- Keep this product away from heat sources. It is designed for use at normal room temperature to ensure reliable operation.
- Do not expose the circuit board to high-intensity light sources, such as xenon flashlights or lasers.
- Operate this product in a well-ventilated environment, and do not cover it during use.
- Place this product on a stable, flat, and insulated surface and avoid contact with conductive materials.
- Handle this product carefully to prevent mechanical or electrical damage to the printed circuit



board and connectors.

- Avoid touching or handling the product when it is powered on. Only touch the edges of the product to minimize the risk of electrostatic discharge damage.
- Any peripherals or devices used with RUBIK Pi 3 must comply with the relevant standards of the country in which it is used and be appropriately marked to ensure safety and performance requirements are met.