

PAA5163E1-QV22: Optical Tracking Chip

General Description

The PAA5163E1-QV22 is PixArt Imaging’s latest optical tracking chip designed to enable navigation up to the speed of 3.8m/s on a wide range of surfaces. The chip is housed in a 6 x 6 x 1.35 mm³ 16-pin land-grid-array (LGA) package with an integrated laser illumination that provides X-Y motion data and consistent resolution. It is suitable for motion tracking in industrial applications.

Key Features

- Performance
 - Speed up to 3.8m/s
 - Working Distance to Tracking Surface range of 15 to 50mm on high gloss surfaces^{*1}
 - Working Distance to Tracking Surface range of 15 to 35mm on medium gloss surfaces^{*2}
 - Typical power consumption of 16.5mA
- No lens required
- Reports accurate XY motion data

Applications

- Devices that require high speed motion detection over a wide working range

Key Parameter

Parameter	Value
Supply Voltage	VDD: 1.8 to 2.1 V VDD_VCSEL: 2.8 to 3.3 V VDDIO: 1.8 to 3.3 V
Working Distance to Tracking Surface	15 to 50 mm ^{*1}
Frame Rate (max.)	20,000 fps
Speed (max.)	3.8 m/s
Acceleration	10 g; 98 m/s ²
Resolution (max.)	20,000 cpi; 7,874 count/cm
Interface	4-Wire SPI @ 4 MHz
Package Size (mm ³)	6 x 6 x 1.35

Note^{*1}: Bare aluminum, glossy stainless steel, glossy photo paper and gypsum board.

Note^{*2}: Laminated wood, green ESD mat and grey vinyl.

Ordering Information

Part Number	Description	Package Type	Packing Type	MOQ
PAA5163E1-QV22	Optical Tracking Chip	16-pin LGA Package	Tape & Reel	500



For any additional inquiries, please contact us at <https://www.pixart.com>

Table of Contents

PAA5163E1-QV22: Optical Tracking Chip 1

 General Description..... 1

 Key Features..... 1

 Applications..... 1

 Key Parameter..... 1

 Ordering Information 1

Table of Contents..... 2

List of Figures..... 4

List of Tables 6

1.0 Introduction 7

 1.1 Overview 7

 1.2 Terminology 7

 1.3 Signal Description..... 8

2.0 Operating Specifications 9

 2.1 Absolute Maximum Ratings 9

 2.2 Recommended Operating Conditions 9

 2.3 DC Characteristics 11

 2.4 AC Characteristics 12

 2.5 Performance Specifications 13

3.0 Mechanical Specifications 15

 3.1 Package Marking 15

 3.2 LGA Package Outline Drawing..... 15

 3.3 Packing Information 16

4.0 Design Reference..... 18

 4.1 General Reference Schematic..... 18

 4.2 Recommended PCB Foot Print..... 19

 4.3 Chip Assembly Tilt 20

 4.4 Keep Out Area 21

 4.5 Recommended Protective Cover Characteristic and Design 22

 4.5.1 Recommended Operating Condition 22

 4.5.2 Protective Cover Characteristics 22

 4.5.3 Recommended Protective Cover Design 23

 4.6 Assembly Guide..... 24

 4.6.1 Handling Precaution of Moisture Sensitivity During Assembly Processes 24

 4.6.2 Assembly Recommendation 25

 4.6.3 ESD Precaution 26

 4.6.4 IR Reflow Soldering Profile..... 27

 4.7 Surface Coverage 28

5.0 Power Management 29

 5.1 Power Supply 29

 5.2 Power Sequence..... 29

 5.2.1 Power On..... 29

 5.2.2 Power Off 30

5.3	Power State.....	30
5.3.1	State Description	30
5.3.2	State Diagram	30
5.3.3	State Transition.....	31
5.4	Reset and Shutdown State	31
5.4.1	Power-on Reset	32
5.4.2	Hardware Reset	32
5.4.3	Software Reset.....	32
5.5	Related Register	32
6.0	Serial Port Interface Communication.....	33
6.1	Signal Description.....	33
6.2	Chip Select Operation.....	33
6.3	Protocol	33
6.4	Write Operation	34
6.5	Read Operation	35
6.6	Burst Mode	36
6.7	Required Timing Between Read and Write Commands (t_{sxx})	37
7.0	System Control	38
7.1	System Initialization	38
7.1.1	Initialization Flow.....	38
7.1.2	Performance Optimization Setting.....	39
7.2	Register Access.....	41
7.2.1	Register Address Mapping	41
7.2.2	Burst Read	41
7.3	Output.....	41
7.3.1	Motion Bit and Motion Pin Interrupt	42
7.3.2	Motion Data and Verification	42
7.3.3	Output Access.....	42
7.3.4	Data Lost and Corruption.....	46
7.3.5	Frame Capture Mode.....	47
7.4	Related Register	48
8.0	Register	49
8.1	Register List.....	49
8.2	Register Description	50
8.2.1	Product ID.....	50
8.2.2	Reset and Shutdown Registers.....	50
8.2.3	Operational Control	51
8.2.4	Motion Related Registers.....	54
8.2.5	Operational Check Related Registers	55
8.2.6	Troubleshooting Related Registers	57
	Revision History	59

List of Figures

Figure 1. Block Diagram7

Figure 2. Pin Configuration8

Figure 3. Chip Orientation vs Moving Direction.....10

Figure 4. Cross Section View of Zs, Zc and ZGAP11

Figure 5. Test setup under bright ambient light14

Figure 6. LGA Package Outline Drawing15

Figure 7. Carrier Tape Dimension and Pin 1 Location16

Figure 8. Photo of the Reel17

Figure 9. Inner Box.....17

Figure 10. Inner Box Label17

Figure 11. Shipping Box17

Figure 12. Shipping Box Label17

Figure 13. Reference Schematic.....18

Figure 14. Recommended PCB Layout in mm [inch]19

Figure 15. Tilt Definition20

Figure 16. Side View and Top View of Keep out Area21

Figure 17. Chip with Flat Cover and Side View22

Figure 18. Cross-sectional View A-A.....23

Figure 19. Kapton Tape Offset Position25

Figure 20. Kapton Tape Peeling Recommendation25

Figure 21. Soldering Reflow Profile27

Figure 22. Power-on Sequence Requirement.....29

Figure 23. State Diagram30

Figure 24. Transmission Protocol.....33

Figure 25. Write Operation34

Figure 26. MOSI Setup and Hold Time34

Figure 27. Read Operation35

Figure 28. MISO Delay and Hold Time35

Figure 29. Burst Read Timing36

Figure 30. Timing Between Two Write Commands37

Figure 31. Timing Between Write and Read Commands37

Figure 32. Timing Between Read and Either Write or Subsequent Read Commands37

Figure 33. Initialization Flow38

Figure 34. Motion Interrupt Pin Function.....42

Figure 35. Polling Method – Single Read43

Figure 36. Polling Method – Burst Read44

Figure 37. Motion Data Access - Interrupt Method.....45

Figure 38. Example of Data Lost When Internal Buffer Reach Limit.....46

Figure 39. Raw Data Map.....48

PixArt Confidential

List of Tables

Table 1. Signal Pins Description8

Table 2. Absolute Maximum Ratings9

Table 3. Recommended Operating Conditions9

Table 4. DC Electrical Specifications11

Table 5. AC Electrical Specifications12

Table 6. Resolution Variation Specifications13

Table 7. Code Identification15

Table 8. Recommended Operating Condition22

Table 9. Soldering Profile27

Table 10. Power State Description30

Table 11. State Transition31

Table 12. State of Signal Pins during Reset and After Reset31

Table 13. State of Signal Pins during Shutdown31

Table 14. 4-Wire SPI Signal Description33

Table 15. Register Map49

PixArt Confidential

1.0 Introduction

1.1 Overview

The PAA5163E1-QV22 is based on Optical Navigation Technology, which measures changes in position by optically acquiring sequential picture elements and mathematically determining the direction and magnitude of movement. The chip contains a Picture Element Acquisition System (PEAS), a hard-coded Digital Signal Processing System (DSPS), and an integrated VCSEL illumination source.

The chip algorithm calculates the speed, direction, magnitude of motion and stores the motion data output information in the registers. Then, the host either uses the polling method or interrupts triggering for immediate access.

Note: Throughout this document, the PAA5163E1-QV22 is referred to as the “chip”.

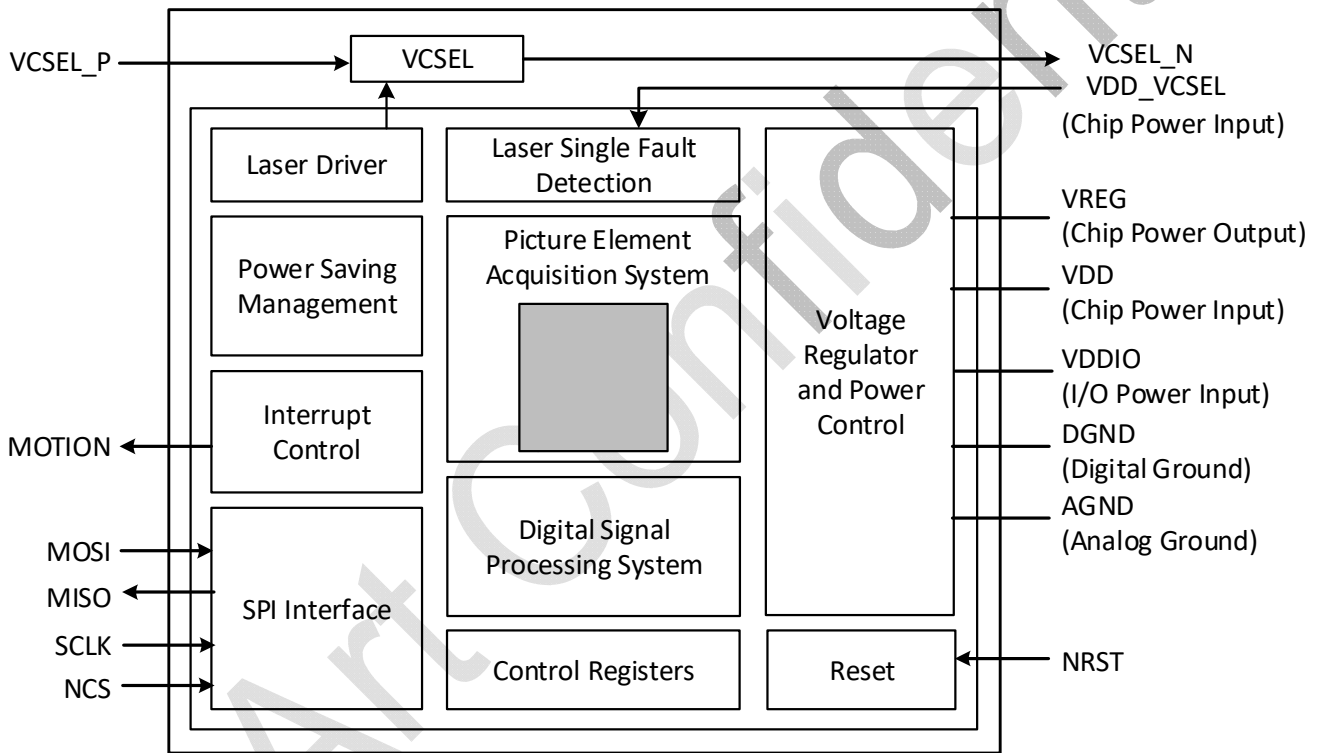
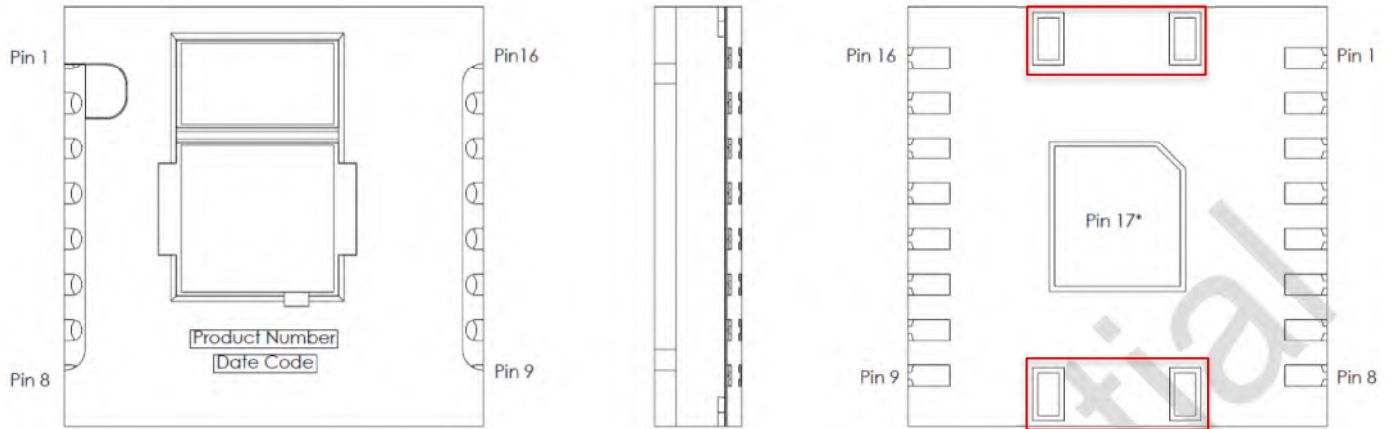

Figure 1. Block Diagram

1.2 Terminology

Term	Description
ESD	Electrostatic Discharge
I/O	Input / Output
VCSEL	Vertical Cavity Surface Emitting LASER
cpi	count per inch
fps	frame per second

1.3 Signal Description



Note: The 4 pads in Figure 2 (red boxed) must be left unconnected.

Figure 2. Pin Configuration

Table 1. Signal Pins Description

Function	Pin No.	Signal Name	Type	Description
Power Supplies	8	DGND	Ground	Digital Ground
	13	AGND	Ground	Analog Ground
	9	VDDIO	Power	I/O power input
	11	VREG	Power	Chip power output
	12	VDD	Power	Chip power input
Control Interface	15	VDD_VCSEL	Power	Chip power input
	3	NCS	Input	Chip select (Active low)
	4	MISO	Output	Serial data output
	5	MOSI	Input	Serial data input
Functional I/O	6	SCLK	Input	Serial data clock
	2	NRST	Input	Hardware reset (Active low)
	7	MOTION	Output	Motion interrupt (Active low)
Special Function Pin	1	VCSEL_P	Input	Laser Anode
	10, 14	NC	NC	No connection (floating)
	16	VCSEL_N	Output	Laser Cathode
	17*	GND PADDLE	Ground	Bottom of LGA package must be connected to circuit ground.

2.0 Operating Specifications

2.1 Absolute Maximum Ratings

Table 2. Absolute Maximum Ratings

Parameter	Symbol	Min.	Max.	Unit	Note
Storage Temperature	T_s	-40	85	°C	
Lead-Free Solder Temperature	T_p		260	°C	
Power Supply Voltage	VDD	-0.5	2.2	V	
	VDD_VCSEL	-0.5	3.5	V	
	VDDIO	-0.5	3.5	V	
I/O pin Voltage	-	-0.5	VDDIO	V	All I/O pins
ESD	ESD _{HBM}		2	kV	All pins (Human Body Model)

Notes:

- Maximum Ratings are the maximum parameter values that can damage the device when exceeding this limit.
- Exposure to these conditions or conditions beyond those indicated may adversely affect device reliability. Functional operation under absolute-maximum-rated conditions is not recommended.

2.2 Recommended Operating Conditions

Table 3. Recommended Operating Conditions

Parameter	Symbol	Min.	Typ.	Max.	Unit	Note
Operating Temperature	T_A	0		60	°C	
Power Supply Voltage	VDD	1.8	1.9	2.1	V	Including supply noise
	VDD_VCSEL	2.8	3.0	3.3	V	Including supply noise
	VDDIO	1.8	1.9	3.3	V	Including supply noise
Power Supply Rise Time	t_{RT}	0.15		20	ms	0 to VDD, VDD_VCSEL & VDDIO min
Supply Noise (Sinusoidal)	V_{NA}			100	mV	Peak to peak noise voltage. 10 kHz to 75 MHz
Serial Port Clock Frequency	f_{SCLK}	0.2		4	MHz	50% duty cycle, for burst mode
	$f_{SCLK-RW}$	1			kHz	50% duty cycle, for individual read and write of register
Resolution	R			20,000	cpi	(7874 count/cm)
Speed @90deg Orientaion ³	S_{90}			3.8	m/s	High Gloss surfaces ⁴
				3.0	m/s	Medium Gloss surfaces ⁵
Speed @45deg Orientaion ³	S_{45}			3.0	m/s	High Gloss surfaces ⁴
				3.0	m/s	Medium Gloss surfaces ⁵
Speed @0deg Orientaion ³	S_0			1.5	m/s	High Gloss surfaces ⁴
				1.5	m/s	Medium Gloss surfaces ⁵
Working Distance from top of Chip to Tracking Surface ⁶	Z_s	15		50	mm	High Gloss surfaces ⁴
		15		35	mm	Medium Gloss surfaces ⁵
Working Distance from top of 1.1mm cover to Tracking Surface, $Z_{GAP}=0.7mm^6$	Z_C	13.2		48.2	mm	High Gloss surfaces ⁴
		13.2		33.2	mm	Medium Gloss surfaces ⁵

Parameter	Symbol	Min.	Typ.	Max.	Unit	Note
Frame Rate	F _R			20,000	fps	
Acceleration	a			98	m/s ²	

Notes:

1. PixArt does not guarantee the performance of the system beyond the recommended operating condition limits.
2. Chip electrical characteristics over recommended operating conditions. Typical values at VDD= 1.9V, VDD_VCSEL= 3.0V, VDDIO= 1.9V, T_A= 25°C.
3. Below are the diagrams of chip orientation vs chip or surface moving direction.

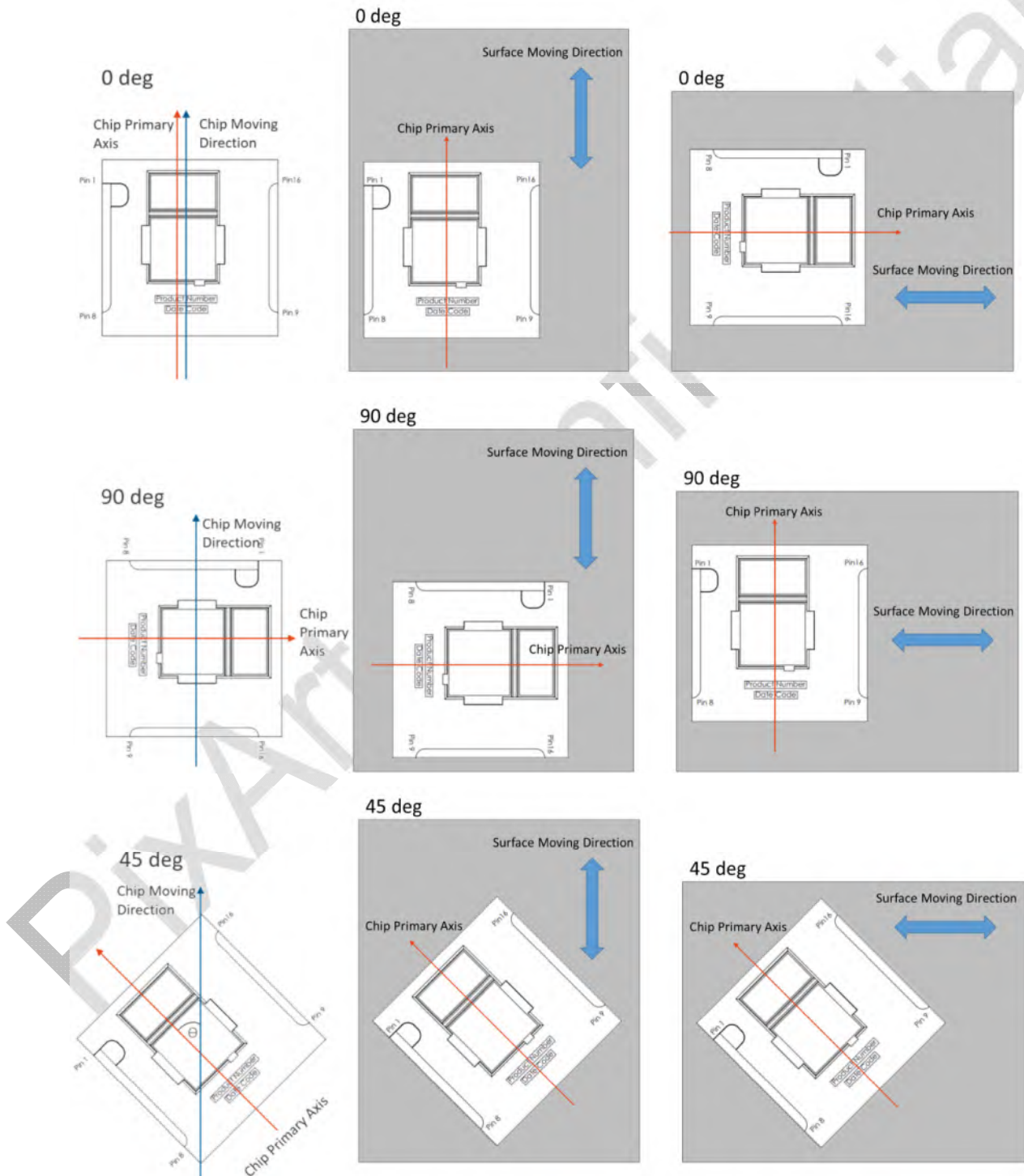

Figure 3. Chip Orientation vs Moving Direction

4. Tested on Bare Aluminum, Glossy Stainless Steel, Glossy Photo Paper and Gypsum Board.
5. Tested on Laminated Wood, Green ESD Mat and Grey Vinyl.
6. Z_s , Z_c and Z_{GAP} . Do refer to section 4.5 for protective cover design.

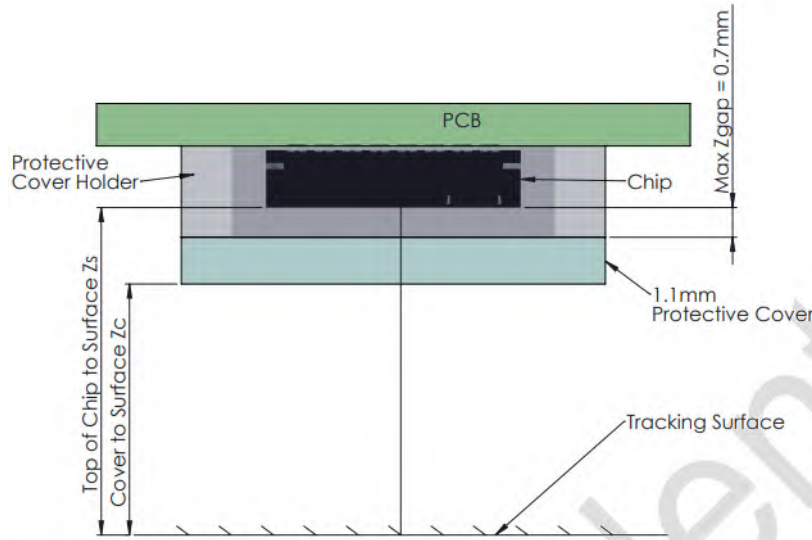

Figure 4. Cross Section View of Z_s , Z_c and Z_{GAP}

2.3 DC Characteristics

Table 4. DC Electrical Specifications

Parameter	Symbol	Min.	Typ.	Max.	Unit	Note
Supply Current	I_{DD_RUN}		14.5		mA	Average current (chip only) No load on MISO, MOTION
	$I_{DD_VCSEL_RUN}$		2		mA	Average current with laser pulsing @ 20k fps
Shutdown state Current	I_{PD}		4		μA	
Input Low Voltage	V_{IL}			$0.3 \times V_{DDIO}$	V	SCLK, MOSI, NCS
Input High Voltage	V_{IH}	$0.7 \times V_{DDIO}$			V	SCLK, MOSI, NCS
Input Hysteresis	V_{I_HYS}		100		mV	SCLK, MOSI, NCS
Input Leakage Current	I_{LEAK}		± 1	± 10	μA	$V_{in} = V_{DDIO}$ or $0V$, SCLK, MOSI, NCS
Output Low Voltage	V_{OL}			0.45	V	$I_{OUT} = 1mA$ for MISO $I_{OUT} = 0.1mA$ for MOTION
Output High Voltage	V_{OH}	$V_{DDIO} - 0.45$			V	$I_{OUT} = -1mA$ for MISO $I_{OUT} = -0.1mA$ for MOTION

Note: Electrical Characteristics are defined under recommended operating conditions. Typical values at $V_{DD} = 1.9V$, $V_{DD_VCSEL} = 3.0V$, $V_{DDIO} = 1.9V$, $T_A = 25^\circ C$.

2.4 AC Characteristics

Table 5. AC Electrical Specifications

Parameter	Symbol	Min.	Typ.	Max.	Unit	Note
Motion Delay After Reset Time	$t_{MOT-RST}$	120			ms	From reset to valid motion, assuming motion is present.
Shutdown State Time	t_{STDWN}			500	ms	From Shutdown State active to low current.
Wake up from Shutdown State Time	t_{WAKEUP}	120			ms	From Shutdown State inactive to valid motion. Note: A RESET must be asserted after a Shutdown State. Refer to section 5.3, also note $t_{MOT-RST}$.
MISO Rise Time	t_{r-MISO}		6		ns	$C_L = 20pF$
MISO Fall Time	t_{f-MISO}		6		ns	$C_L = 20pF$
MISO Delay After SCLK	$t_{DLY-MISO}$			35	ns	From SCLK falling edge to MISO data valid. $C_L = 20pF$.
MISO Hold Time	$t_{hold-MISO}$	25			ns	Data held until next falling SCLK edge.
MOSI Hold Time	$t_{hold-MOSI}$	25			ns	Amount of time data is valid after SCLK rising edge.
MOSI Setup Time	$t_{setup-MOSI}$	25			ns	From data valid to SCLK rising edge.
SPI Time Between Write Commands	t_{SWW}	5			μs	From rising SCLK for last bit of the first data byte, to rising SCLK for last bit of the second data byte.
SPI Time between Write and Read Commands	t_{SWR}	5			μs	From rising SCLK for last bit of the first data byte, to rising SCLK for last bit of the second address byte.
SPI Time between Read and Subsequent Commands	t_{SRW} , t_{SRR}	2			μs	From rising SCLK for last bit of the first data byte, to falling SCLK for the first bit of the address byte of the next command.
SPI Read Address-Data Delay	t_{SRAD}	2			μs	From rising SCLK for last bit of the address byte, to falling SCLK for first bit of data being read.
NCS Inactive After Motion Burst	t_{BEXIT}	500			ns	Minimum NCS inactive time after motion burst before next SPI usage
NCS To SCLK Active	$t_{NCS-SCLK}$	120			ns	From last NCS falling edge to first SCLK rising edge.
SCLK To NCS Inactive (For Read Operation)	$t_{SCLK-NCS}$	120			ns	From last SCLK rising edge to NCS rising edge, for valid MISO data transfer.
SCLK To NCS Inactive (For Write Operation)	$t_{SCLK-NCS}$	1			μs	From last SCLK rising edge to NCS rising edge, for valid MOSI data transfer.

Parameter	Symbol	Min.	Typ.	Max.	Unit	Note
NCS To MISO High-Z	t _{NCS-MISO}			500	ns	From NCS rising edge to MISO high-Z state.
MOTION Rise Time	t _{r-MOTION}		300		ns	C _L = 20pF
MOTION Fall Time	t _{f-MOTION}		300		ns	C _L = 20pF
Input Capacitance	C _{in}		10		pF	SCLK, MOSI, NCS.
Load Capacitance	C _L			20	pF	MISO, MOTION
Transient Supply Current	I _{DDT}			70	mA	Maximum supply current during the supply ramp from 0V to VDD with minimum 150 μs and maximum 20 ms rise time (does not include charging currents for bypass capacitors).
	I _{DDTIO}			60	mA	Maximum supply current during the supply ramp from 0V to VDDIO with minimum 150 μs and maximum 20 ms rise time (does not include charging currents for bypass capacitors).

Note: Electrical Characteristics are defined under recommended operating conditions. Typical values at VDD= 1.9V, VDD_VCSEL= 3.0V, VDDIO= 1.9V, T_A= 25°C.

2.5 Performance Specifications

Table 6. Resolution Variation Specifications

Parameter	Symbol	Min.	Typ.	Max.	Unit	Note
Resolution Variation ^{1,2}	RV		1		%	At constant Speed and Working Distance from Tracking Surface @ 787 count/ cm.
Resolution Variation ^{1,2} (Over Height)	RV _H		4		%	At constant Speed, across Working Distance from Tracking Surface range @ 787 count/ cm.
Resolution Variation ^{1,2} (Over Speed)	RV _S		3		%	At constant Working Distance from Tracking Surface, up to max. Speed @ 787 count/ cm.

Note:

- Resolution Variation, $RV = \frac{\text{Max}[(R_{\text{max}} - R_{\text{average}}), (R_{\text{average}} - R_{\text{min}})]}{(R_{\text{average}})} \times 100\%$.
- Tested under normal office lighting at 300 to 400 lux.
- The chip can operate under bright ambient light of up to 5k lux, warm white (refer to Figure 5), but the RV may increase up to 10% on certain surfaces, for example, white paper.

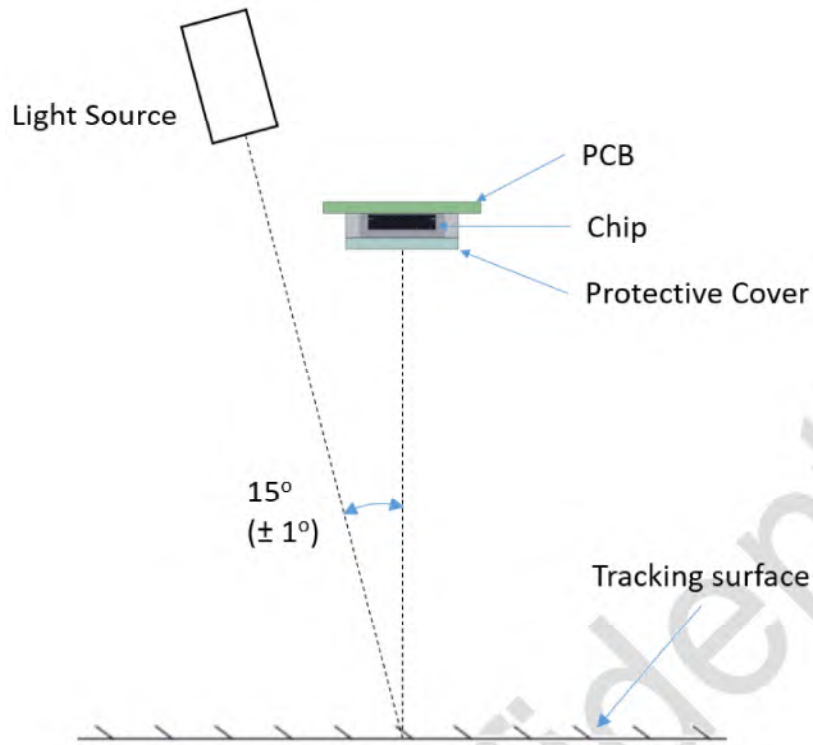

Figure 5. Test setup under bright ambient light

3.0 Mechanical Specifications

3.1 Package Marking

Refer to Figure 2. Pin Configuration for the code marking location on the device package.

Table 7. Code Identification

Label	Marking	Description
Product Number	P5163	Part number label
Date Code	YWX	Y: Year W: Week X: Reserved as PixArt reference

3.2 LGA Package Outline Drawing

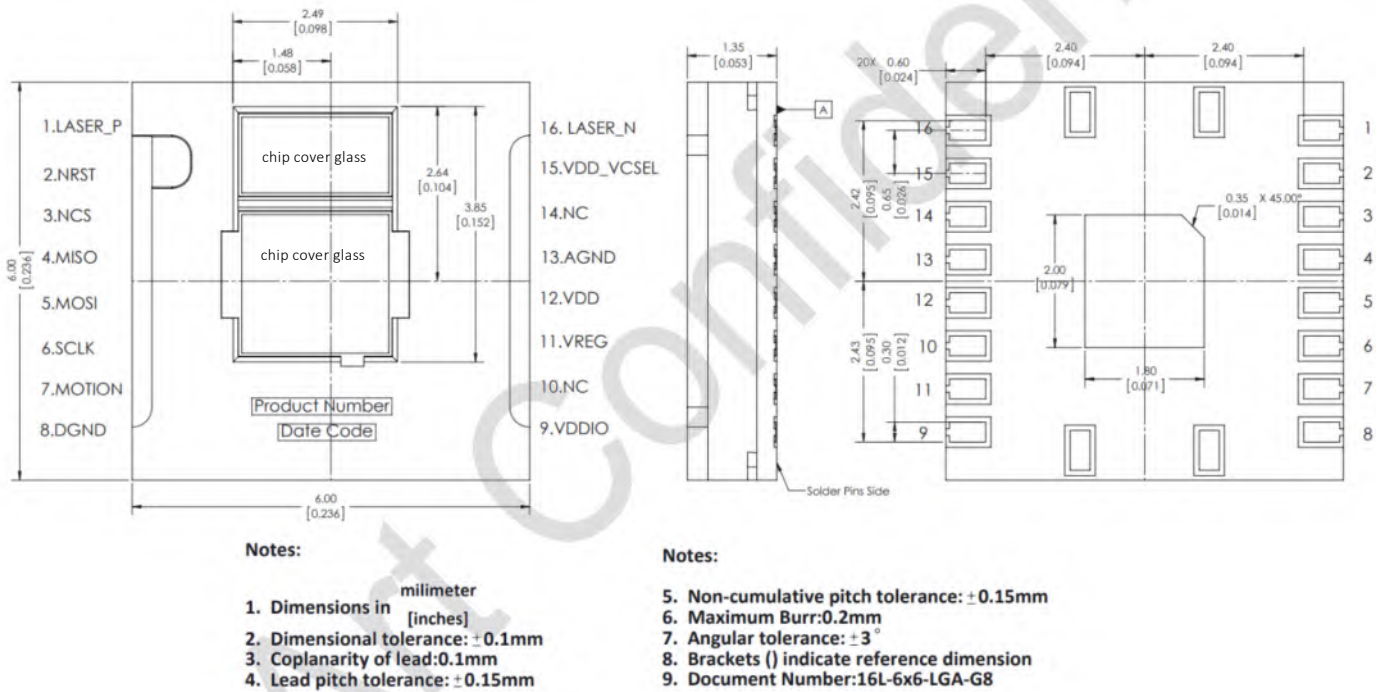

Note: It is advised that normal static discharge precautions be taken in handling and assembling of this component to prevent damage and/or degradation which may be induced by ESD.

Figure 6. LGA Package Outline Drawing

3.3 Packing Information

Parameter	Description
Part Number	PAA5163E1-QV22
Package Type	16 Pins LGA
Quantity per reel	500 pcs
Inner Box Quantity	500 pcs [1 reel per inner box]
Shipping Box Quantity	2,500 pcs [5 inner boxes per shipping box]
Inner box size	270 x 270 x 45 mm ³
Shipping Box size	190 x 190 x 295 mm ³

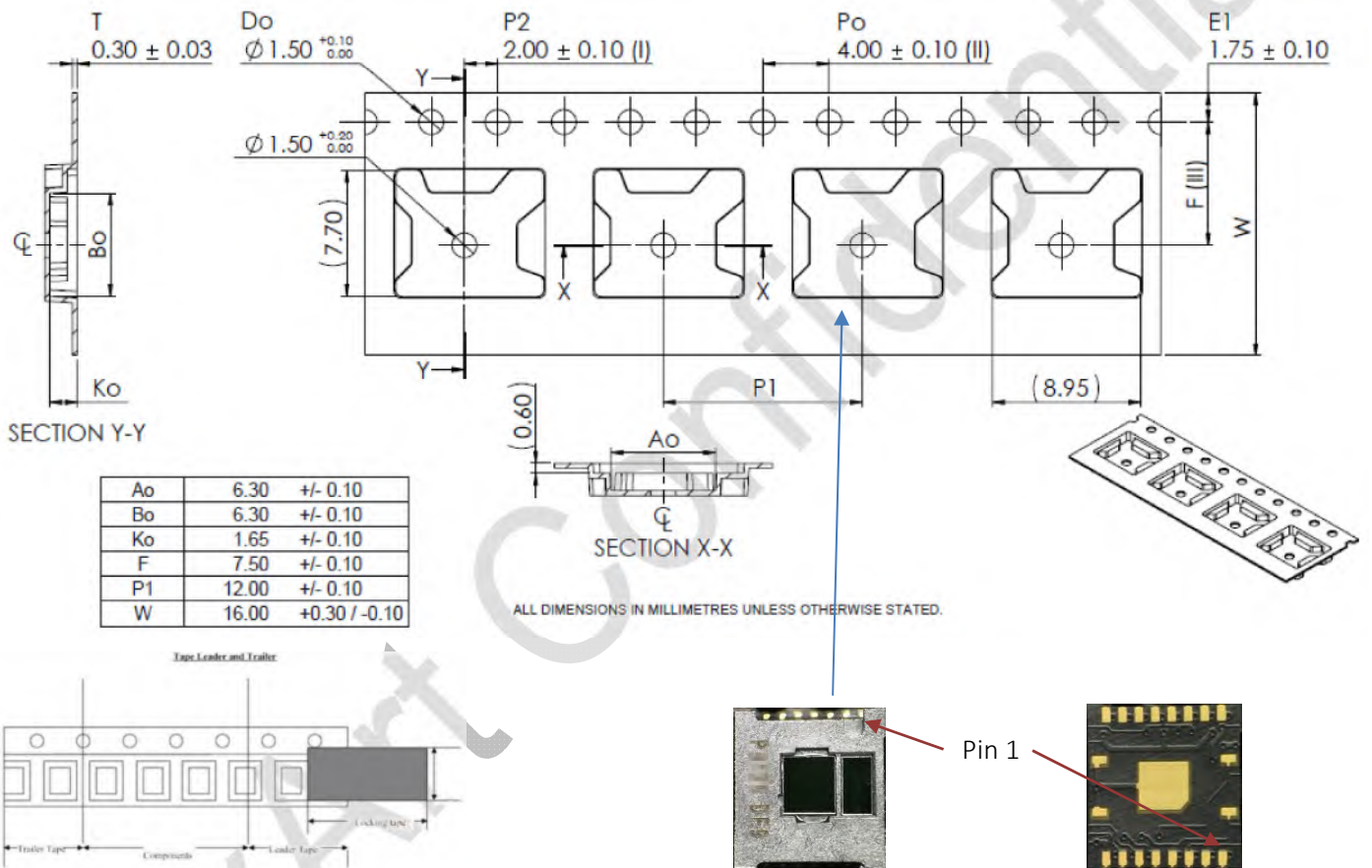



Figure 8. Photo of the Reel



Figure 9. Inner Box



Figure 10. Inner Box Label



Figure 11. Shipping Box



Figure 12. Shipping Box Label

4.0 Design Reference

4.1 General Reference Schematic

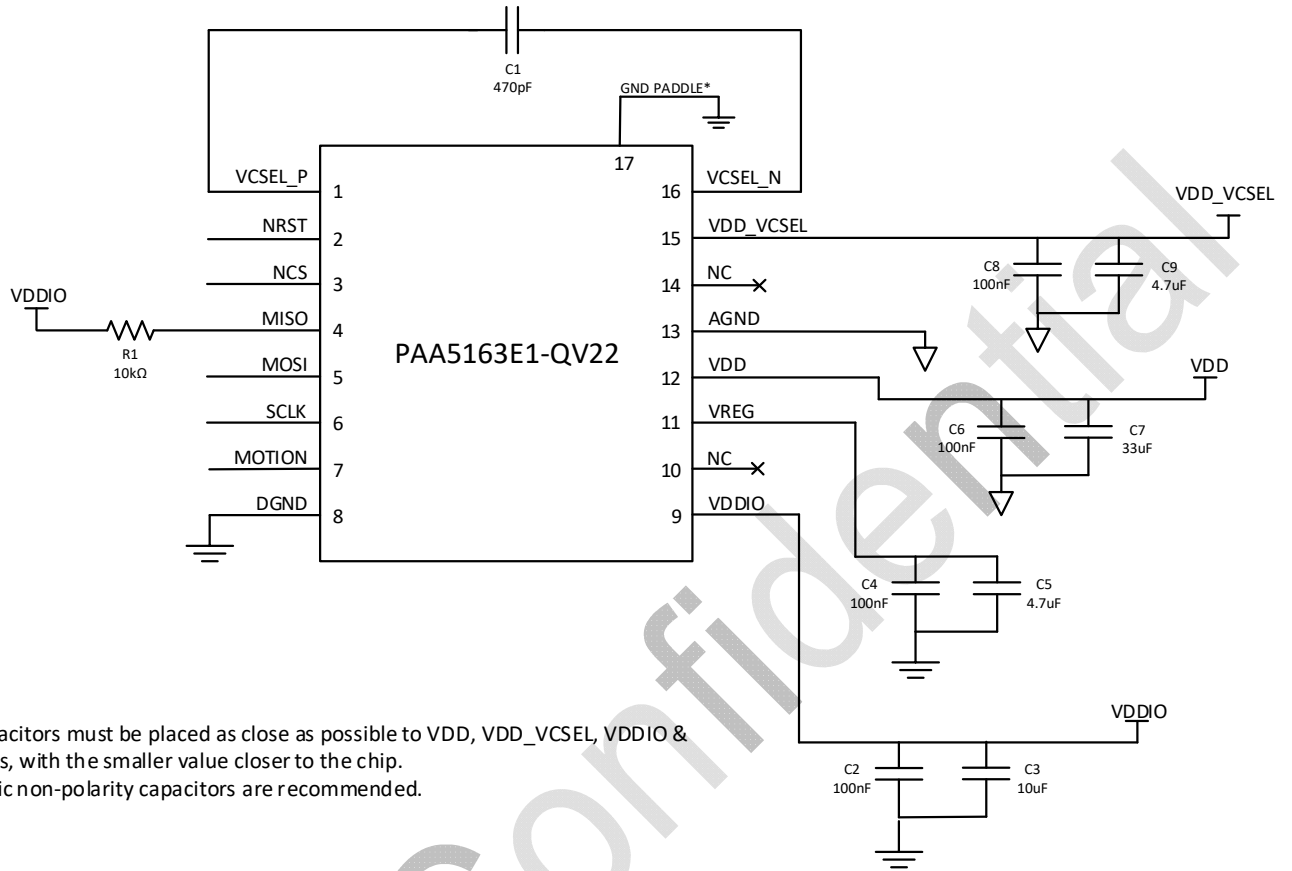

Note:

1. All capacitors must be placed as close as possible to VDD, VDD_VCSEL, VDDIO & VREG pins, with the smaller value closer to the chip.
2. Ceramic non-polarity capacitors are recommended.

Figure 13. Reference Schematic

4.2 Recommended PCB Foot Print

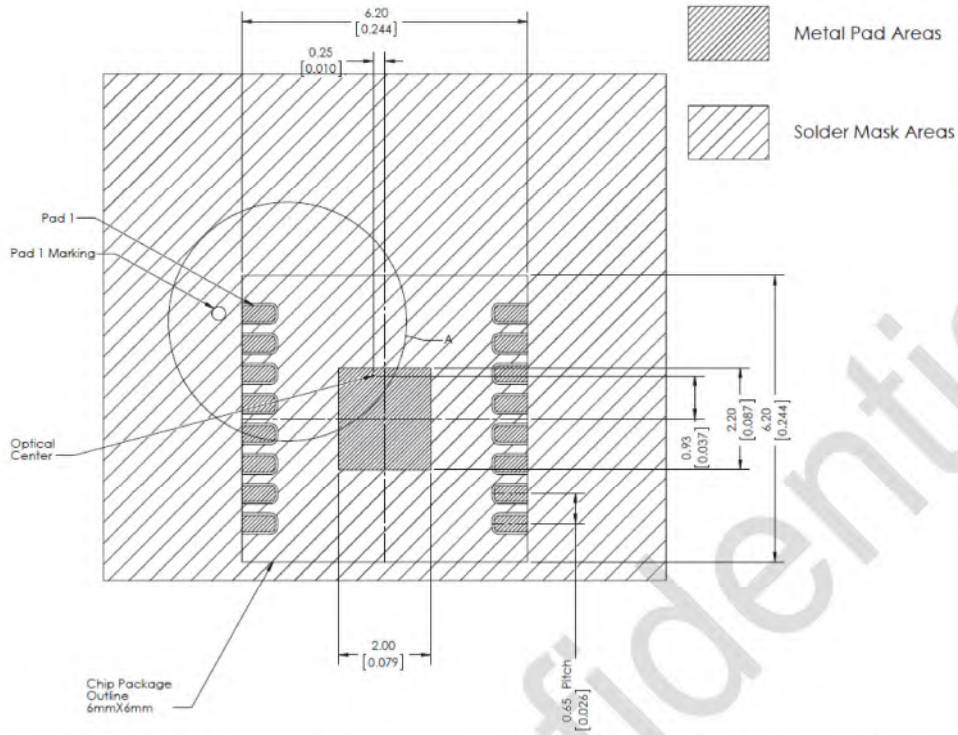

Note: Bottom center pad of LGA package must be connected to circuit ground

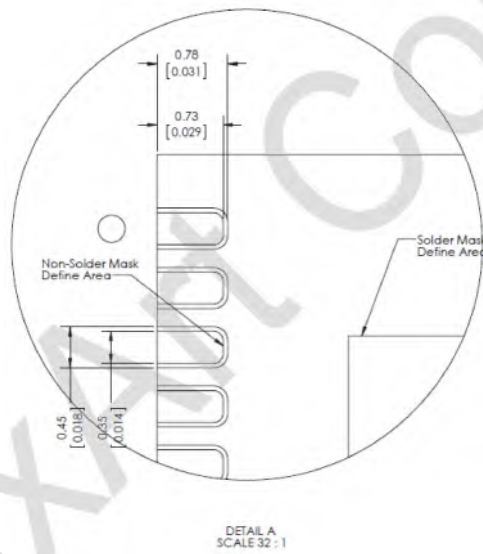

Notes:

- 1. Dimensions in millimeter [inches]
- 2. Dimensional tolerance: $\pm 0.1\text{mm}$
- 3. Coplanarity of lead: 0.1mm
- 4. Lead pitch tolerance: $\pm 0.15\text{mm}$
- 5. Non-cumulative pitch tolerance: $\pm 0.15\text{mm}$
- 6. Angular tolerance: $\pm 3^\circ$
- 7. Brackets () indicate reference dimension

Figure 14. Recommended PCB Layout in mm [inch]

4.3 Chip Assembly Tilt

For optimal performance, there should be minimal tilt to the assembly of the chip on the PCB. The tilt should not be more than 3 degrees for trackable surfaces.

If the tilt angle is larger than 3 degrees, the Resolution Variation % will increase significantly over the working range stated in Table 3.

Chip Tilt Angles are defined per below drawings from view A and view B.

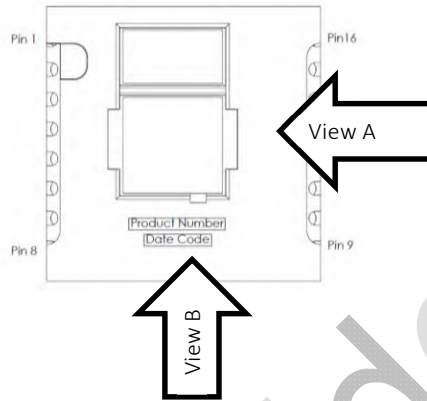

View A

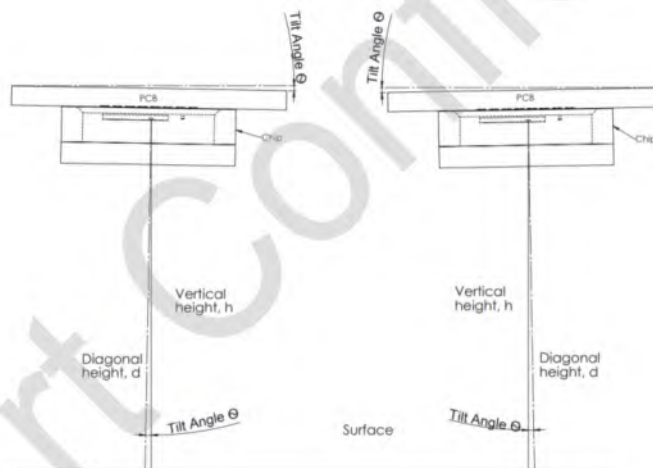

View B

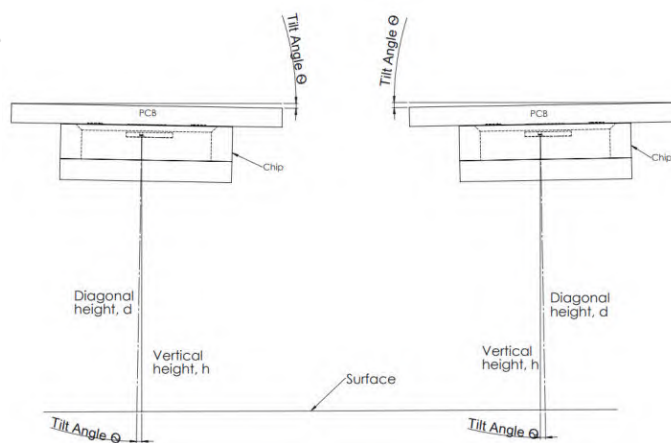

Figure 15. Tilt Definition

4.4 Keep Out Area

A keep out area of 25° angle is recommended to ensure the optical path of the chip is not blocked.

The 25° angle is from the top of the protective cover for the chip.

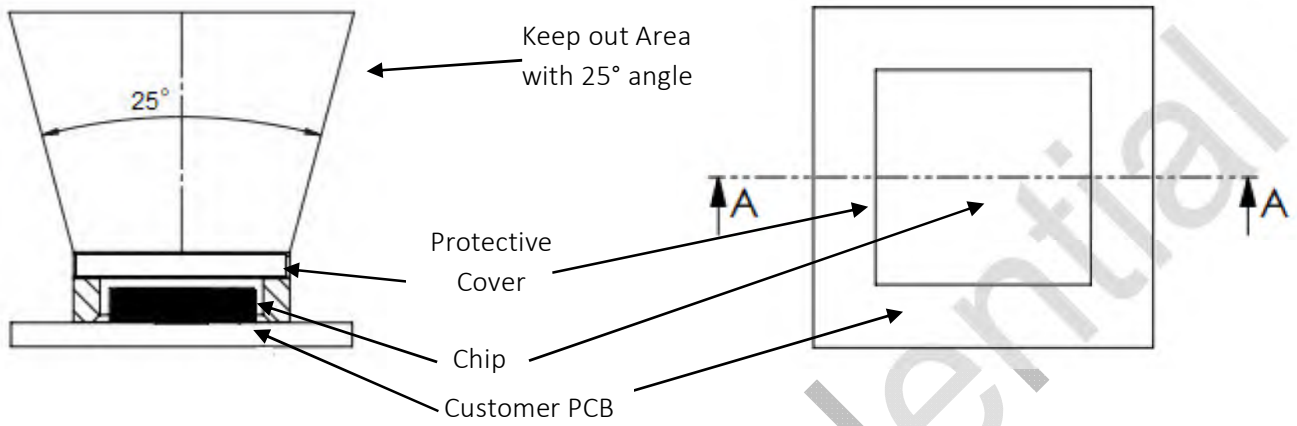

Figure 16. Side View and Top View of Keep out Area

4.5 Recommended Protective Cover Characteristic and Design

For optimum performance of the chip when used with protective cover, below are guidelines on the design and characteristics of the protective cover.

4.5.1 Recommended Operating Condition

Table 8. Recommended Operating Condition

Parameter	Symbol	Min.	Typ.	Max.	Unit	Note
Z_GAP (Cover Bottom to top of the chip)	Z _{GAP}			0.7	mm	Measured from bottom of cover to chip top surface

4.5.2 Protective Cover Characteristics

- Based on the operating principle of the chip, the wavelength range of 800 to 900 nm is critical to the chip's performance. As such, the recommended protective cover material is double sided AR coating with transmissivity of >97% over wavelength of 800 to 900nm.
- Protective cover holder below is used to hold the protective cover which can be custom made per customer's requirement
- Both sides of the cover are coated with anti-reflective material.
- Recommended thickness for the cover is 1.1 ± 0.1mm and placed above the chip as below:

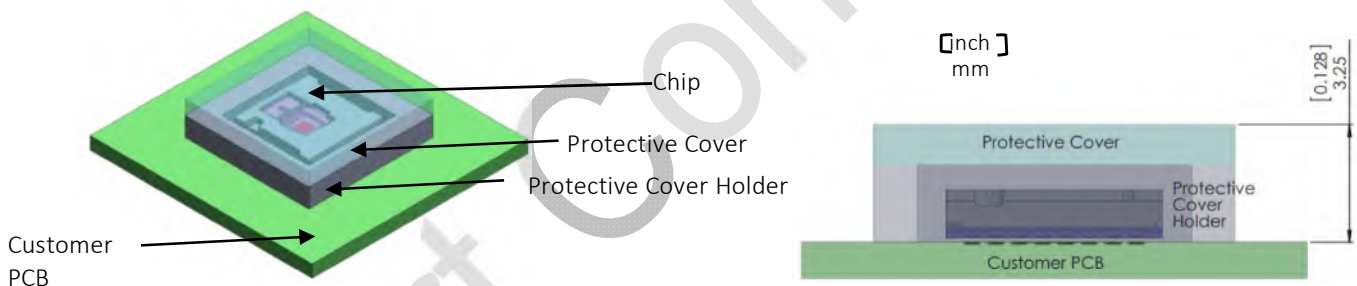
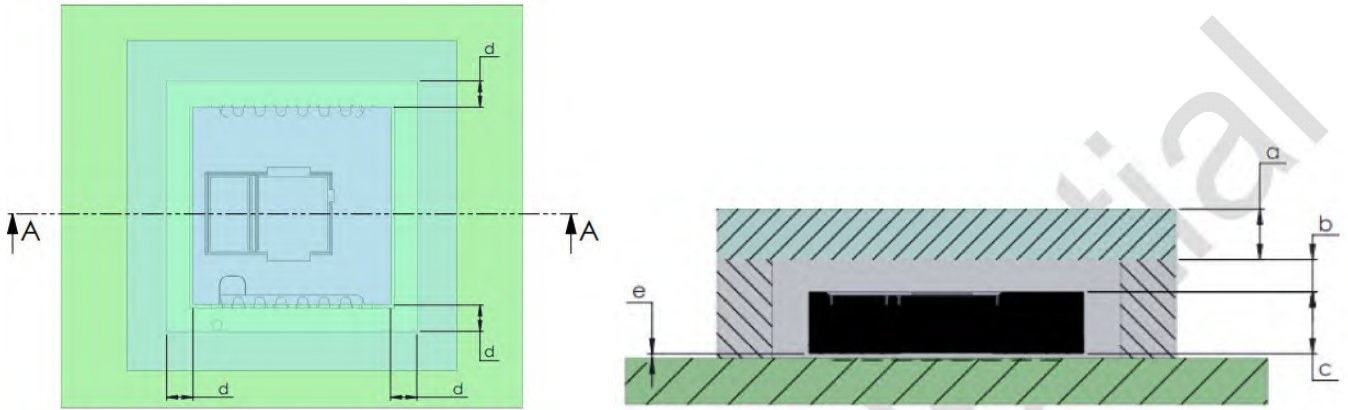

Figure 17. Chip with Flat Cover and Side View

4.5.3 Recommended Protective Cover Design

Cross-sectional view in Figure 18 below shows the recommended protective cover design, which is with the cover sitting above the chip (example below is with maximum Z_{GAP} of 0.7mm). Dimensions d (gaps between chip and cover holder) just needs to be larger than the chip when mounted on the customer PCB.



	Dimension	Value
a.	Cover Thickness	1.10mm
b.	Z_{GAP} between chip and cover	0.70mm
c.	Chip Thickness	1.35mm
d.	X/Y gap between chip and cover holder	> 0mm
e.	Chip solder thickness	0.10mm

Figure 18. Cross-sectional View A-A

4.6 Assembly Guide

4.6.1 Handling Precaution of Moisture Sensitivity During Assembly Processes

This product is classified as moisture sensitivity device at Level 3 (MSL 3). Thus, the following moisture sensitive precaution and handling steps are required during the Assembly processes.

Storage Control of Unopened box/ Seal bag

This product will be shipped in a vacuum sealed Moisture Barrier bag (MBB) together with desiccant and a moisture indicator card inside.

The shelf life in the unopened sealed bag is 12 months at storage condition of $< 40^{\circ}\text{C}/90\%$ relative humidity (RH). It is advised that the vacuum sealed MBB only be opened at the START of assembly process.

Control of Opened Seal bag

After the vacuum sealed MBB is opened, the product MUST be subjected to reflow solder and PCB mounting within **168 hours** of the factory condition $< 30^{\circ}\text{C}/60\%$ RH.

Control of Un-reflow Units

Any balance of un-reflow units need to be sealed back to the MBB with desiccant at $< 5\%$ RH.

The product requires Baking, before mounting, if the following conditions happen:

- Assembly floor life exceeded 168 hours after the sealed MBB is opened.
- Humidity Indicator Card (HIC) is $> 10\%$ when read at $23 \pm 5^{\circ}\text{C}$.

Recommended Baking condition is $125 \pm 10^{\circ}\text{C}$ for 48 hours. Refer to IPC/JEDEC J-STD-033 for Baking procedures.

4.6.2 Assembly Recommendation

For surface mount the chip and all other components onto PCB:

1. Reflow the entire assembly in a no-wash solder process.

Note: Recommended to generate a stencil for the reflow process.

2. Remove the protective Kapton tape on top of the chip's package, which is meant to protect the cover glasses on top of the chip as shown in Figure 6 from contamination.

Note: The glass on the chip package may be cleaned with lint-free material and IPA if required.

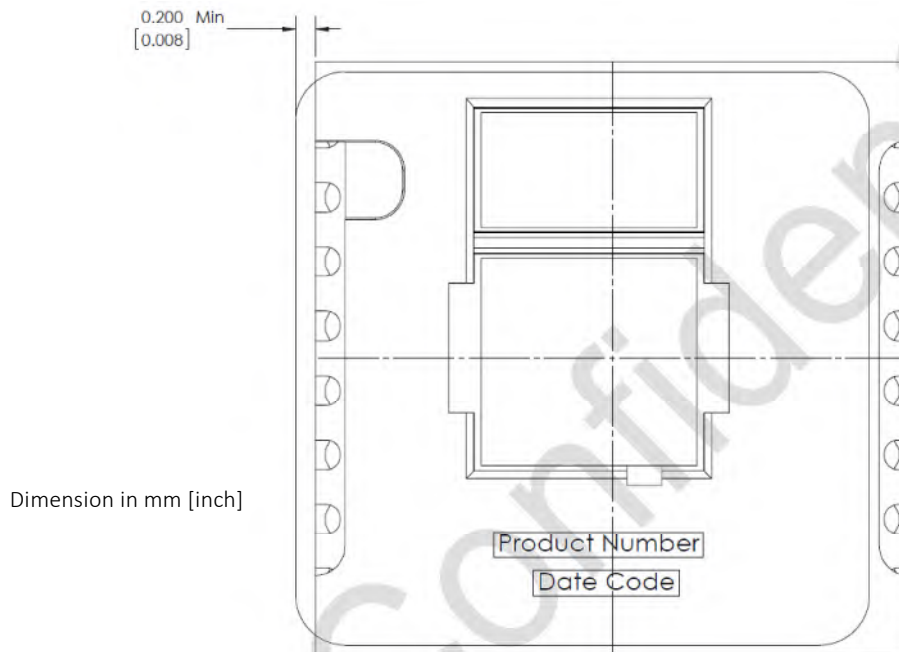

Figure 19. Kapton Tape Offset Position

The Kapton tape has a minimum of 0.2mm offset from the chip package to ease the Kapton tape peeling. It is recommended to use flat head tweezers, by using the flat region of the tip to remove the tape, as shown in Figure 20.

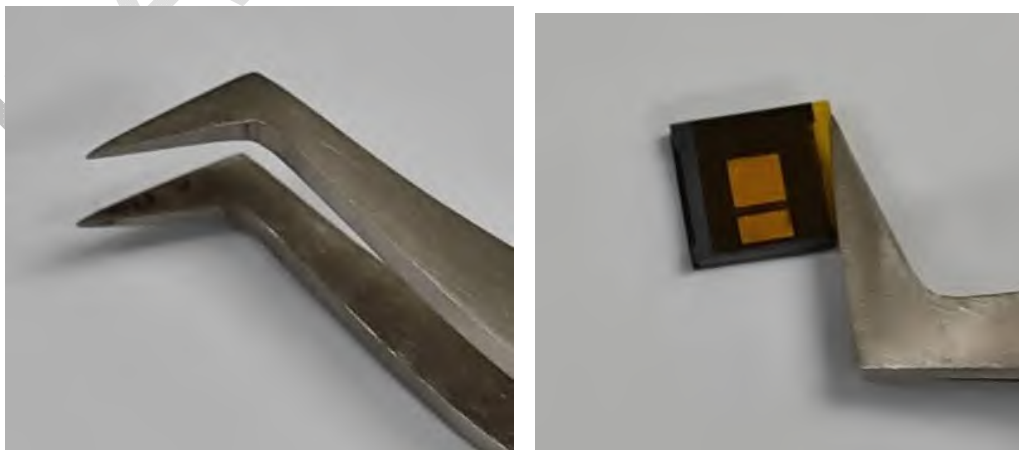

Figure 20. Kapton Tape Peeling Recommendation

4.6.3 ESD Precaution

This chip is a sensitive device, ESD awareness is mandatory to prevent premature damage during handling.

Below are recommended procedures to prevent electrostatic discharge towards semiconductor devices:

- Equalize potentials of terminals during transportation or storage.
- Equalize the potentials of all electronic devices, workstation, and operator's body that may have possible contact with the chip.
- Ensure maintaining an ESD free environment at all times. For example, maintain relative humidity in the work area to around 50%.

Operator

- Operators must wear wrist straps in contact with bare skin.
- Wear cotton or anti-static treated materials, clothing, and gloves.
- Wear conductive shoes whenever a conductive mat is used.
- Do not touch the pins, hold the body of the chip instead.

Equipment and Tools

- Any electrical equipment and tool placed on the workbench must be isolated from the work bench's surface, and need to be grounded properly.
- Conductive mat (or conductive material) must be used on workbench's surface. These conductive materials must be grounded with a 1 MΩ resistor.

Transportation, Storage and Packing

- Use conductive or anti-static shielding bags to store chips.

Soldering Operation

- Use a soldering iron with a grounding wire.
- During manual soldering operation, the operator must wear wrist straps.
- Do not use the solder removal pump when detaching the chip from PCB. Use solder wick or equivalent tools.

4.6.4 IR Reflow Soldering Profile

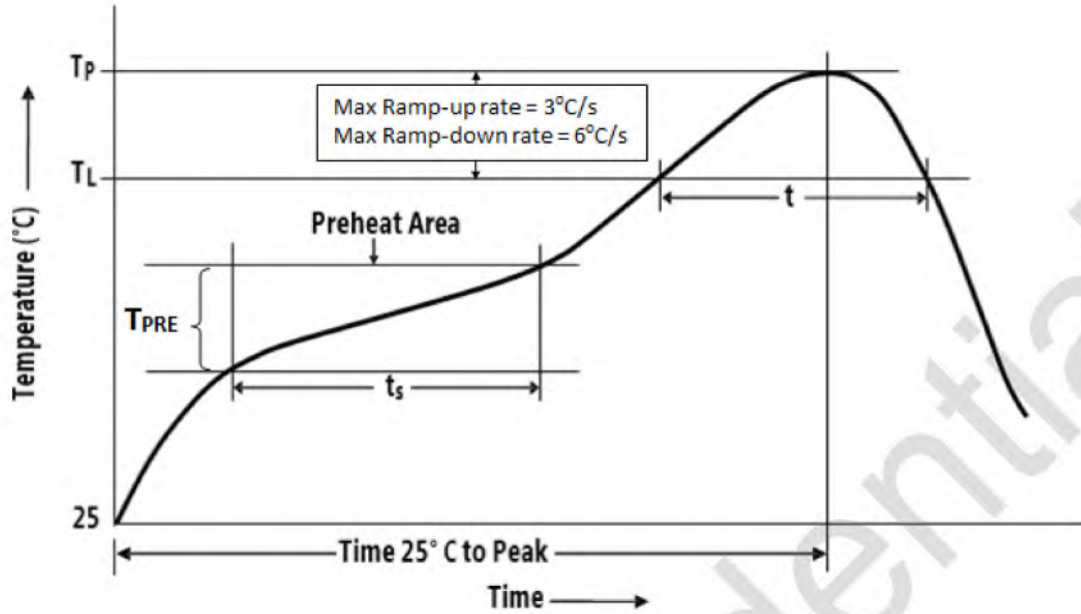

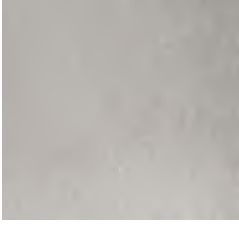
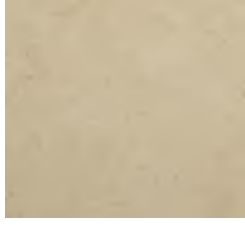

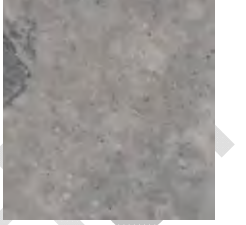



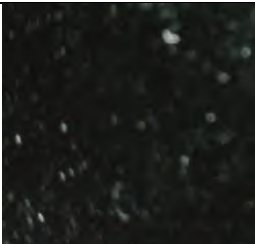









Figure 21. Soldering Reflow Profile

Table 9. Soldering Profile

Parameter	Symbol	Min.	Max.	Unit	Note
Preheat Area Temperature	T_{PRE}	150	200	°C	
Preheat Area Duration	t_s	60	120	sec	From 150 to 200°C
Melting Duration	t	60	150	sec	$T \geq 217^\circ\text{C}$
Liquids Melting Temperature	T_L	217		°C	
Peak Temperature	T_P	230	260	°C	
Ramp-up rate	T_{RAMP_UP}		3	°C/sec	From T_L to T_P
Ramp-down rate	T_{RAMP_DOWN}		6	°C/sec	From T_P to T_L
Max. Time 25°C to Peak			5	min	

4.7 Surface Coverage

While the chip can track on a variety of common surfaces such as glossy metal, glossy non-metal and tiles, there are some challenges to track on dark, absorptive, and very rough surfaces (highlighted in red below), where tracking performance or working range may be impacted. Refer to below figure for examples of the surfaces mentioned.

High Gloss	Medium Gloss	Wood	Others
			
Aluminum	Glossy Gypsum Flooring	Laminated Wood	Concrete Surface
			
Glossy Stainless Steel	Glossy Grey Vinyl Flooring	Light Brown Wood	Dark Absorptive Art Paper
			
Dark Granite	Green ESD Mat	Dark Plywood	Very Rough Tiles
	Others 	Carpet 	
Glossy Photo Paper	Diffuse A4 Paper	Black Carpet	Dark Absorptive Rubber Mat (with or without Color Spots)
			
	Black Painted Metal	Crimson Carpet	Rough Vinyl Flooring (Wood Pattern)