



# Strikefan Electronic Co.,Ltd

## APPROVAL SHEET

Customer : \_\_\_\_\_  
Model No : TRD4028B24SH  
Part No : C(1)  
Description : DC Fan (RoHS)  
Date : 2023 / 4 / 27  
Revision : \_\_\_\_\_

CUSTOMER APPROVED	CHECKED BY	PREPARED BY
	陳祐仁	洪莉嫻

THIS OFFER IS MADE ACCORDING TO YOUR CURRENT INQUIRY. UNLESS OTHERWISE REVISED, THIS SPECIFICATION WILL BE FINAL FOR ALL FUTURE PRODUCTION ORDERS FROM YOUR RESPECTED COMPANY KINDLY STUDY IN DETAILS AND RETURN TO US THE DUPLICATE DULY SIGNED AS YOUR CONFIRMATION OF SAME





Strikefan Electronic Co.,Ltd.

# SPECIFICATION

## DC AXIAL FAN

ITEM	DESCRIPTIONS
P/N	TRD4028B24SH-C.B(1)
Dimension 尺寸	40x40x28mm
Bearing Type 軸承	Two Ball Bearing
Rated Voltage 額定電壓	24 VDC
Operating Voltage 工作電壓範圍	15~27 VDC
Startup Voltage 啟動電壓	15 V
Rated Current 額定電流	0.61 A
Consuming Power 消耗功率	14.64 W
Rated Speed 額定轉速	25000 RPM±10%
Air Flow 風量	32.71( Min:29.44) CFM
	0.93( Min:0.83) m <sup>3</sup> /min
Static Pressure 靜壓	96.66(Min:78.29) mm-H <sub>2</sub> O
	3.81(Min:3.08) inch-H <sub>2</sub> O
Noise Level 噪音	64(Max:70.4) dBA
Safety Certification 安規	TUV UL CUL CE

## SPECIAL FUNCTION TYPE 特殊功能類型

Auto Restart By IC 自動重啓 (IC版)	YES
Soft Start 軟啟動	NO
Speed Control (FG) 速度檢測	NO
Alarm Control (RD) 警示功能	YES
Pulse Width Modulation 脈寬調控	YES
Temperature Control 溫度控制	NO
Waterproof Level 防水等級	NO

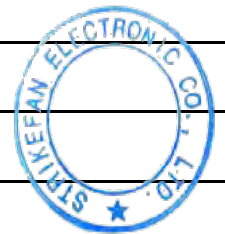



**1.MATERIAL:**

1-1.FRAME :PBT UL94V-0

1-2.IMPELLER PBT UL94V-0

1-3.BOBBIN PBT UL94V-0

1-4.Shaft holder :

V	Plastic		Copper
	Aluminum		

**2.ENVIRONMENTAL:**

2-1.OPERATING TEMPERATURE : -10 TO +70 DEGREE°C

2-2.STORAGE TEMPERATURE : -40 TO +85 DEGREE°C

2-3.OPERATING HUMIDITY : 15 TO 90% RH

2-4.STORAGE HUMIDITY : 15 TO 90% RH

**3. Electrical specification :**

3-1.LOCKED ROTOR PROTECTION

IMPEDANCE OF MOTOR WINDING PROTECTS MOTOR FROM FIRE IN 15MINUTE OF LOCKED ROTOR CONDITION AT THE RATED VOLTAGE.

3-2.INSULATION RESISTANCE

10 MEG OHM( MIN.) AT 500 VDC (BETWEEN FRAME AND (+) TERMINAL)

3-3.INSULATION STRENGTH

5 mA MAX. AT 500 VAC 60 Hz ONE MINUTE, (BETWEEN FRAME AND(+))TERMINAL)

**4.Drop test:**

IN MINIMUM PACKAGING CONDITION FAN WITHSTANDS EACH ONE DROP OF THREE FACES FROM 30 CM DISTANCE HEIGHT ONTO 10 MM THICKNESS OF WOODEN BOARD.

**5.LIFE EXPECTANCY:**

70000 HOURS CONTINUOUS OPERATION

ONE YEAR WARRANTY AT 40°C WITH 15~65 %RH..





### 6.Fan Performance Curve Test Report

## Test Conditions

Barometric Pressure:	752.4	Test Voltage:	At rated Voltage
Relative humidity:	66.83%	Test Temp. :	25 °C

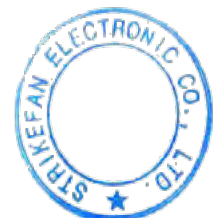
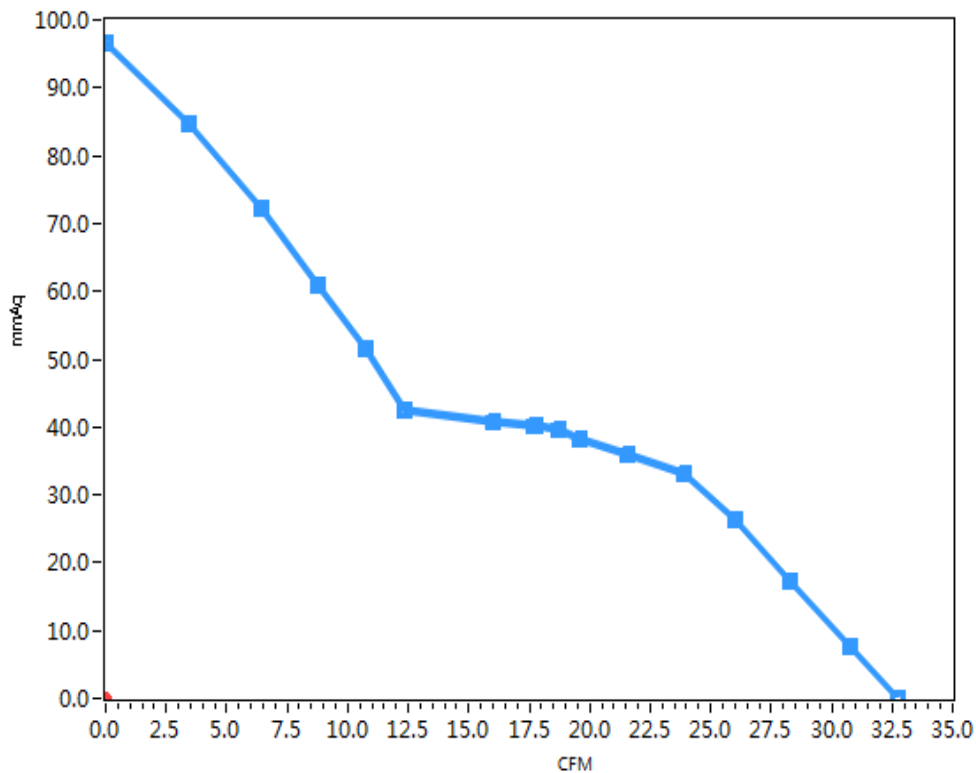



### 7.OUTLINE STYLING & DIMENSIONS :

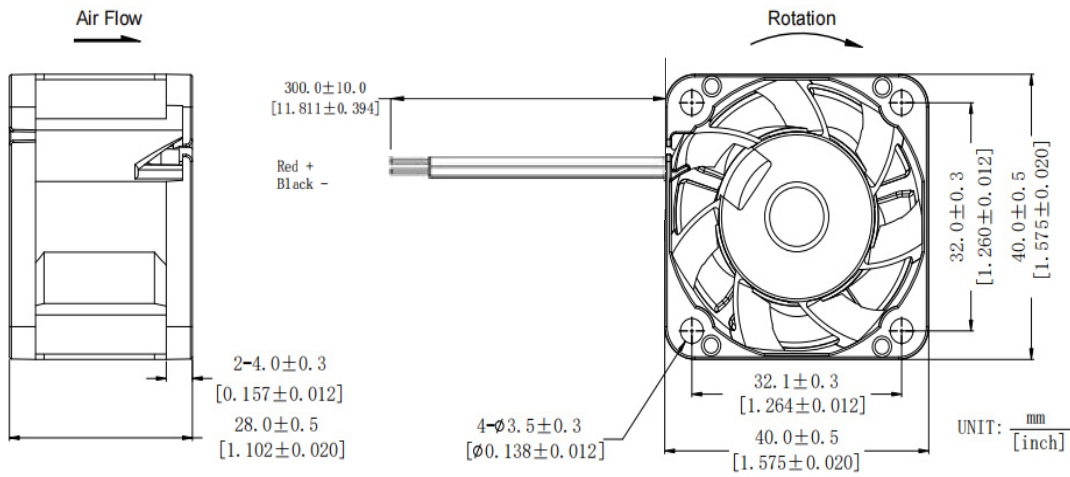

(1) 型號/Model No
(2) 軸承/Bearing Type
(3) 額定電壓/Rated Voltage
(4) 安規電流/Rated Current
(5) 產品編號/Part No
(6) 安規/Safety Approvals
(7) 製造日期/Date Code



NOTE:

LEAD WIRES: WIRES UL 1332 #28 AWG

Red-----(+)

Black-----(-)

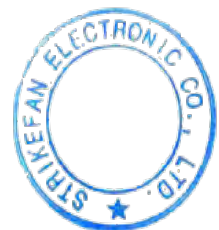

## 10. Operation notice:

1. PLEASE DO NOT TOUCH AND PUSH FAN BLADE WITH FINGERS OR OTHERS, FAN BLADE AND BALL BEARINGS MAY BE DAMAGED AND IT CAUSES NOISE DEFECT.
2. DO NOT CARRY THE FAN BY ITS LEAD WIRES.
3. IF THE FAN DOES NOT HAVE THE POLARITY PROTECTION FUNCTION,THE CONNECTION OF THE COLORED WIRES SHOULD BE RED+RED, AND BLACK+BLACK,OR ELSE THE FAN WILL BE DAMAGED IN NO TIME.
4. FOR THE MODELS WITHOUT REVERSE CONNECTION OF POLARITY PROTECTION, PLEASE DO NOT CONNECT THE LEAD WIRE IN REVERSE.
5. PLEASE DON'T INSTALL THIS FAN IN SERIES WITH 2X VOLTAGE INPUTS. FOR EXAMPLE, IF A SINGLE FAN RATED AT 12V,THEN DON'T INSTALL TWO OF THEM IN SERIES WITH 24V INPUT.
6. THE PERIOD OF PRODUCT WARRANTY,UNLESS OTHERWISE AGREED BY STK IN WRITTEN, SHALL BE 12 MONTHS STARTING FROM THE DATE OF PRODUCTION.
7. IN ORDER TO AVOID ABNORMAL BUMPING OR INTERFERENCE CAUSED BY DEFORMED IMPELLER WHEN FAN IS FASTENED,SUGGESTED DISTANCE OF AT LEAST 0.5MM IS STRONGLY RESERVED IN FRONT OF THE FRAME(THE SIGHT FROM THE IMPELLER FACE).

## 11. Fan noise test:

1. ALL READINGS ARE MEASURED AFTER STABLY WARMING UP THROUGH 10 MINUTES.
2. THE VALUES WRITTEN IN PARENS, ARE LIMITED SPEC.
3. ACOUSTICAL NOISE MEASURING CONDITION:

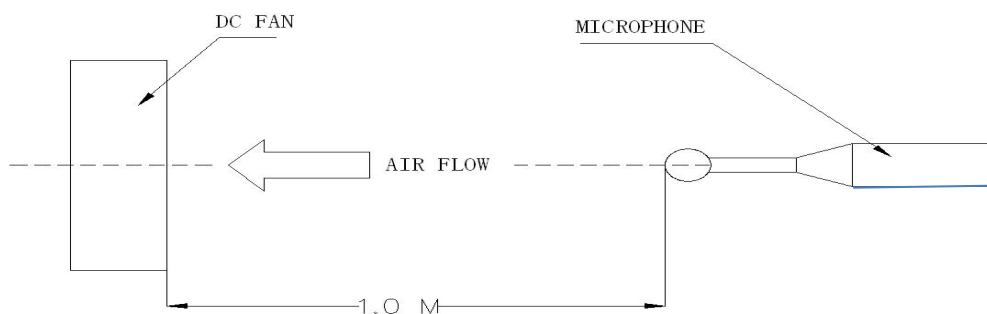

NOISE IS MEASURED AT RATED VOLTAGE IN FREE AIR IN ANECHOIC CHAMBER WITH B & K SOUND LEVEL METER WITH MICROPHONE AT A DISTANCE OF ONE METER FROM THE FAN INTAKE

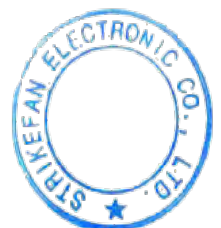

# GPWV8.E350026 - Fans, Electric Certified for Canada - Component

Note: We are enhancing our systems and you may notice duplicate entries/missing/outdated data. During this interim period, please contact our Customer Service at <https://www.ul.com/about/locations>.

## Fans, Electric Certified for Canada - Component

### STRIKEFAN ELECTRONIC CO LTD

E350026

4F No.100 Zhongxing Rd  
Xizhi District  
New Taipei, 221012 Taiwan

Marking: Company name model designation, and the Recognized Component Mark for Canada

Note: For additional marking information, refer to the [Guide Information Page](#).

Model(s): S(X)07138812L-3M ((X)=S or B), S(X)07138812M-3M ((X)=S or B), SB0501012(Y) - where (Y)=H,M or L, SB0501012(Y)-3M - where (Y)=H,M or L, SB0701512(Y) - where (Y)=H,M or L, SB0701512(Y)-3M - where (Y)=H,M or L, T- RDB9733(X)18H (X) may be B or S., TRB1232(X)12H, TRB1232(X)12L, TRB1232(X)12M, TRB1232(X)12VH, TRB1232(X)24H, TRB1232(X)24L, TRB1232(X)24M, TRB1232(X)24VH, TRB5015(X)12H, TRB5015(X)12L, TRB5015(X)12M, TRB5015(X)12VH, TRB5015(X)24H, TRB5015(X)24L, TRB5015(X)24M, TRB5015(X)24VH, TRB7530(X)12H (X) may be B or S., TRB7530(X)12L (X) may be B or S., TRB7530(X)12M (X) may be B or S, TRB7530(X)24H, TRB7530(X)24L, TRB7530(X)24M, TRB7530(X)24VH, TRB7530S12VH (X) may be B or S., TRB9733(X)24H, TRB9733(X)24L, TRB9733(X)24M, TRB9733(X)24VH, TRD1225(X)24H, TRD1225(X)24L, TRD1225(X)24M, TRD1225(X)24VH, TRD1238(X)24H (X) may be B or S., TRD1238(X)24L, TRD1238(X)24M (X) may be B or S., TRD1238(X)24VH (X) may be B or S., TRD1751B24H, TRD1751B24L, TRD1751B24M, TRD1751B24SH, TRD1751B24UH, TRD1751B24VH, TRD2589(X)48H (X) may be B or S., TRD2589(X)48L (X) may be B or S., TRD2589(X)48M (X) may be B or S., TRD2589(X)48SH (X) may be B or S., TRD2589(X)48VH (X) may be B or S., TRD4028(X)12SH (X) may be B or S., TRD6038(X)24H (X) may be B or S., TRD6038(X)24L (X) may be B or S., TRD6038(X)24M (X) may be B or S., TRD6038(X)24SH (X) may be B or S., TRD6038(X)24VH (X) may be B or S, TRD8032(X)12SH (X) may be S, B, L, F., TRD8038(X)24H (X) may be B or S., TRD8038(X)24L (X) may be B or S., TRD8038(X)24M (X) may be B or S., TRD8038(X)24SH (X) may be B or S., TRD8038(X)24VH (X) may be B or S, TRD9225(X)24H (X) may be B or S, TRD9225(X)24L (X) may be B or S, TRD9225(X)24M (X) may be B or S, TRD9225(X)24SH (X) may be B or S., TRD9225(X)24VH (X) may be B or S., TRD9232(X)12SH (X) may be S, B, L, F., TRD9232(X)24SH (X) may be S, B, L, F., TRD9238(X)24H (X) may be B or S., TRD9238(X)24L (X) may be B or S., TRD9238(X)24M (X) may be B or S., TRD9238(X)24VH (X) may be B or S., TRD9238(X)48H (X) may be B or S., TRD9238(X)48L (X) may be B or S., TRD9238(X)48M (X) may be B or S., TRD9238(X)48VH (X) may be B or S., TRDB9733(X)18HH (X) may be B or S., TRDB9733(X)18L (X) may be B or S., TRDB9733(X)18M (X) may be B or S., TRDB9733S18H (X) may be B or S., TRS1238(X)48H (X) may be B or S., TRS1238(X)48L, TRS1238(X)48M (X) may be B or S., TRS1238(X)48SH (X) may be B or S., TRS1238(X)48UH (X) may be B or S., TRS1238(X)48VH (X) may be B or S., TRS1725B12D, TRS1725B12H, TRS1725B12L, TRS1725B12M, TRS1725B24D, TRS1725B24H, TRS1725B24L, TRS1725B24M, TRS1725B24VH, TRS1751B24H, TRS1751B24L, TRS1751B24M, TRS1751B24SH, TRS1751B24VH, TRS2510(X)12H (X) may be B or S, TRS2510(X)12L (X) may be B or S., TRS2510(X)12M (X) may be B or S., TRS2510(X)12VH (X) may be B or S., TRS3010(X)05H, TRS3010(X)05L, TRS3010(X)05M, TRS3010(X)12H (X) may be B or S., TRS3010(X)12L (X) may be B or S., TRS3010(X)12M (X) may be B or S., TRS3010(X)12SH (X) may be B or S., TRS3010(X)12VH (X) may be B or S, TRS3510(X)05H, TRS3510(X)05L, TRS3510(X)05M, TRS3510(X)12H, TRS3510(X)12L, TRS3510(X)12M, TRS4010(X)12H (X) may be B or S., TRS4010(X)12L (X) may be B or S., TRS4010(X)12M (X) may be B or S., TRS4010(X)12SH (X) may be B or S, TRS4010(X)12VH (X) may be B or S., TRS4010(X)15H, TRS4010(X)15L, TRS4010(X)15M, TRS4010(X)24H, TRS4010(X)24L, TRS4010(X)24M, TRS4015(X)12H (X) may be B or S., TRS4015(X)12L (X) may be B or S., TRS4015(X)12M (X) may be B or S., TRS4015(X)12SH (X) may be B or S., TRS4015(X)12VH (X) may be B or S, TRS4015(X)24H, TRS4015(X)24L, TRS4015(X)24M, TRS5010(X)24H, TRS5010(X)24L, TRS5010(X)24M, TRS5015(X)12H (X) may be B or S, TRS5015(X)12L (X) may be B or S., TRS5015(X)12M (X) may be B or S., TRS5015(X)12VH (X) may be B or S., TRS5015(X)24H, TRS5015(X)24L, TRS5015(X)24M, TRS6015(X)24H, TRS6015(X)24L, TRS6015(X)24M, TRS6020(X)12H, TRS6020(X)12L, TRS6020(X)12M, TRS6020(X)24H, TRS6020(X)24L, TRS6020(X)24M, TRS6020(X)24VH (X) may be S, B, L, F., TRS6025(X)12H (X) may be B or S, TRS6025(X)12L (X) may be B or S, TRS6025(X)12M (X) may be B or S, TRS6025(X)12V (X) may be B or S

Model(s): TRB7525(X)12VH - where (X) may be S, B, L or F

Model(s): TRB7525(X)24D - where (X) may be S, B, L or F

Model(s): TRB7525(X)24H - where (X) may be S, B, L or F

Model(s): TRB7525(X)24L - where (X) may be S, B, L or F

Model(s): TRB7525(X)24M - where (X) may be S, B, L or F

Model(s): TRB7525(X)24VH - where (X) may be S, B, L or F

Model(s): TRD4028(X)12H - where (X) may be S, B, L or F

Model(s): TRD4028(X)12L - where (X) may be S, B, L or F

Model(s): TRD4028(X)12M - where (X) may be S, B, L or F

Model(s): TRD4028(X)12VH - where (X) may be S, B, L or F

Model(s): TRD4028(X)24H - where (X) may be S, B, L or F

Model(s): TRD4028(X)24L - where (X) may be S, B, L or F

Model(s): TRD4028(X)24M - where (X) may be S, B, L or F

Model(s): TRD4028(X)24SH - where (X) may be S, B, L or F

Model(s): TRD4028(X)24VH - where (X) may be S, B, L or F

Model(s): TRD5010(S)12H Where "(S)" or "(X)" means bearing type, may be "S" or "B".

Model(s): TRD5010(S)12HH Where "(S)" or "(X)" means bearing type, may be "S" or "B".

Model(s): TRD5010(S)12L Where "(S)" or "(X)" means bearing type, may be "S" or "B".

Model(s): TRD5010(S)12M Where "(S)" or "(X)" means bearing type, may be "S" or "B".

Model(s): TRS1238(X)24H Where "(S)" or "(X)" means bearing type, may be "S" or "B".

Model(s): TRS1238(X)24HH Where "(S)" or "(X)" means bearing type, may be "S" or "B".

Model(s): TRS1238(X)24L Where "(S)" or "(X)" means bearing type, may be "S" or "B".

Model(s): TRS4010(X)24SH - where (X) may be S, B, L or F

Model(s): TRS6015(X)05H Where "(S)" or "(X)" means bearing type, may be "S" or "B".

Model(s): TRS6015(X)05HH Where "(S)" or "(X)" means bearing type, may be "S" or "B".

Model(s): TRS6015(X)05L Where "(S)" or "(X)" means bearing type, may be "S" or "B".

Model(s): TRS6015(X)05M Where "(S)" or "(X)" means bearing type, may be "S" or "B".

**AC fans,** Model(s): SA12025(A)1H(B)(Y) , (A) may be S or B, (B) may be L or T, (Y) may be letter A through Z and/or 0 through 9, or blank

**AC fans,** Model(s): SA12038(A)1H(B)(Y) , (A) may be S or B, (B) may be L or T, (Y) may be letter A through Z and/or 0 through 9, or blank

**AC fans,** Model(s): SA15050(A)1H(B)(Y) , (A) may be S or B, (B) may be L or T, (Y) may be letter A through Z and/or 0 through 9, or blank



# GPWV2.E350026 - Fans, Electric - Component

Note: We are enhancing our systems and you may notice duplicate entries/missing/outdated data. During this interim period, please contact our Customer Service at <https://www.ul.com/about/locations>.

## Fans, Electric - Component

### STRIKEFAN ELECTRONIC CO LTD

E350026

4F No.100 Zhongxing Rd  
Xizhi District  
New Taipei, 221012 Taiwan

Marking: Company name and model designation.

Note: For additional marking information, refer to the [Guide Information Page](#).

Model(s): S(B)0701512LC(D), S(X)07138812L-3M ((X)=S or B), S(X)07138812M-3M ((X)=S or B), S(X)0802524(Y)D, SB0501012(Y) where (Y)=H,M or L, SB0501012(Y)-3M where (Y)=H,M or L, SB0701512(Y) where (Y)=H,M or L, SB0701512(Y)-3M where (Y)=H,M or L, SB1232(Y)24H - Y may be C, B or S, SB1232(Y)24L - Y may be C, B or S, SB1232(Y)24M - Y may be C, B or S, SB5015(Y)24H - Y may be C, B or S, SB5015(Y)24L - Y may be C, B or S, SB5015(Y)24M - Y may be C, B or S, SB6028(Y)12H - Y may be C, B or S, SB6028(Y)12L - Y may be C, B or S, SB6028(Y)12M - Y may be C, B or S, SB7530(Y)12L - Y may be C, B or S, SB7530(Y)12M - Y may be C, B or S, SB9733(Y)12H - Y may be C, B or S, SB9733(Y)12M - Y may be C, B or S, SB9733(Y)24H - Y may be C, B or S, SB9733(Y)24L - Y may be C, B or S, SB9733(Y)24M - Y may be C, B or S, SD1225(Y)24H - Y may be C, B or S, SD1225(Y)24L - Y may be C, B or S, SD1225(Y)24M - Y may be C, B or S, SD1238(Y)24H - Y may be C, B or S, SD1238(Y)24L - Y may be C, B or S, SD1238(Y)24M - Y may be C, B or S, SD2510(Y)12H - Y may be C, B or S, SD2510(Y)12L - Y may be C, B or S, SD2510(Y)12M - Y may be C, B or S, SD3010(Y)12H - Y may be C, B or S, SD3010(Y)12L - Y may be C, B or S, SD3010(Y)12M - Y may be C, B or S, SD4010(Y)12H - Y may be C, B or S, SD4010(Y)12L - Y may be C, B or S, SD4010(Y)12M - Y may be C, B or S, SD4028(Y)12H - Y may be C, B or S, SD4028(Y)12L - Y may be C, B or S, SD4028(Y)12M - Y may be C, B or S, SD5010(Y)12H - Y may be C, B or S, SD5010(Y)12L - Y may be C, B or S, SD5010(Y)12M - Y may be C, B or S, SD6015(Y)12H - Y may be C, B or S, SD6015(Y)12L - Y may be C, B or S, SD6015(Y)12M - Y may be C, B or S, SD6020(Y)12H - Y may be C, B or S, SD6020(Y)12L - Y may be C, B or S, SD6020(Y)12M - Y may be C, B or S, SD7015(Y)12H - Y may be C, B or S, SD7015(Y)12L - Y may be C, B or S, SD7015(Y)12M - Y may be C, B or S, SD8038(Y)12H - Y may be C, B or S, SD8038(Y)12L - Y may be C, B or S, SD8038(Y)12M - Y may be C, B or S, SD8038(Y)24H - Y may be C, B or S, SD8038(Y)24L - Y may be C, B or S, SD8038(Y)24M - Y may be C, B or S, SD9225(Y)24H - Y may be C, B or S, SD9225(Y)24L - Y may be C, B or S, SD9225(Y)24M - Y may be C, B or S, SD9232(Y)12H - Y may be C, B or S, SD9232(Y)12L - Y may be C, B or S, SD9232(Y)12M - Y may be C, B or S, SD9232(Y)24H - Y may be C, B or S, SD9232(Y)24L - Y may be C, B or S, SD9232(Y)24M - Y may be C, B or S, SD9238(Y)12H - Y may be C, B or S, SD9238(Y)12L - Y may be C, B or S, SD9238(Y)12M - Y may be C, B or S, SD9238(Y)24H - Y may be C, B or S, SD9238(Y)24L - Y may be C, B or S, SD9238(Y)24M - Y may be C, B or S, SRL(A) (B)1402512LB(D), TRD1751B24H, TRD1751B24L, TRD1751B24M, TRD1751B24SH, TRD1751B24UH, TRD1751B24VH, TRD8032(X)12SH, TRD9232(X)12SH, TRD9232(X)24SH, TRDB9733(X)18HH, TRDB9733(X)18L, TRDB9733(X)18M, TRS1725B12D, TRS1725B12H, TRS1725B12L, TRS1725B12M, TRS1725B24D, TRS1725B24H, TRS1725B24L, TRS1725B24M, TRS1725B24VH, TRS6025(X)24SH, TRS7025(X)24H, TRS8020(X)12VH, TRS8020(X)24VH, TRSF9225(X)2425A, TRSF9225(X)2430A, TRSF9225(X)2435A, TRSF9225(X)2440A, TRSH1225(X)2418A, TRSH1225(X)2421A, TRSH1225(X)2424A, TRSH1225(X)2427A

Model(s): S (X)0601512(Y)B refers to where (X)=S or B, (Y)=H,M or L

Model(s): S(A)0601012(B)(C) (A) may be S, B or SB. (B) may be L, M, H or HH. (C) may be "-3M" or blank

Model(s): S(B)0602512H (D) refers to where (B) may be S, B or SB. (D) may be "-3M" or blank

Model(s): S(B)0602512HH (D) refers to where (B) may be S, B or SB. (D) may be "-3M" or blank

Model(s): S(B)0602512L (D) refers to where (B) may be S, B or SB. (D) may be "-3M" or blank

Model(s): S(B)0602512M (D) refers to where (B) may be S, B or SB. (D) may be "-3M" or blank

Model(s): SRL(A)(B)1402512M(D) refers to where (A) may be XX,X may be 0-9 or A-Z,(B) may be S,B or SB, (D) may be "-3M" or blank ,(E) may be black,G or I.

Model(s): SRL(X) (Y) 1202512LIW (X)=xx,x may be from 0 to 9 or from A to Z, (Y) may be B or S

Model(s): SRL(X) (Y)1202512LGW (X)=xx,x may be from 0 to 9 or from A to Z, (Y) may be B or S

Model(s): SSI0Z B09238(C)(D)(XXX) (mm) - Where (C) may be 12, 24, 48, (D) may be L, M, H, (XXX) may be blank, -3M, P-4M.

Model(s): TRB7525(X)12D - where (X) may be S, B, L or F

Model(s): TRB7525(X)12H - where (X) may be S, B, L or F

Model(s): TRB7525(X)12L - where (X) may be S, B, L or F

Model(s): TRB7525(X)12M - where (X) may be S, B, L or F

Model(s): TRB7525(X)12VH - where (X) may be S, B, L or F

Model(s): TRB7525(X)24D - where (X) may be S, B, L or F

Model(s): TRB7525(X)24H - where (X) may be S, B, L or F

Model(s): TRB7525(X)24L - where (X) may be S, B, L or F

Model(s): TRB7525(X)24M - where (X) may be S, B, L or F

Model(s): TRB7525(X)24VH - where (X) may be S, B, L or F

Model(s): TRD4028(X)12H - where (X) may be S, B, L or F

Model(s): TRD4028(X)12L - where (X) may be S, B, L or F

Model(s): TRD4028(X)12M - where (X) may be S, B, L or F

Model(s): TRD4028(X)12VH - where (X) may be S, B, L or F

Model(s): TRD4028(X)24H - where (X) may be S, B, L or F

Model(s): TRD4028(X)24L - where (X) may be S, B, L or F

Model(s): TRD4028(X)24M - where (X) may be S, B, L or F

Model(s): TRD4028(X)24SH - where (X) may be S, B, L or F

Model(s): TRD4028(X)24VH - where (X) may be S, B, L or F

Model(s): TRS4010(X)24SH - where (X) may be S, B, L or F

Model(s): TRY12025(Y)12H - Where (Y) may be "S", "B" or "SB"

Model(s): TRY12025(Y)12L - Where (Y) may be "S", "B" or "SB"

Model(s): TRY12025(Y)12M - Where (Y) may be "S", "B" or "SB"

Model(s): TRY12025(Y)24H - Where (Y) may be "S", "B" or "SB"

Model(s): TRY12025(Y)24L - Where (Y) may be "S", "B" or "SB"

Model(s): TRY12025(Y)24M - Where (Y) may be "S", "B" or "SB"

Model(s): TRY12032(Y)24H - Where (Y) may be "S", "B" or "SB"

Model(s): TRY12032(Y)24L - Where (Y) may be "S", "B" or "SB"



Product Service

# CERTIFICATE

No. B 118976 0002 Rev. 00

**Holder of Certificate:** **STRIKEFAN ELECTRONIC CO.,LTD.**

4F., No. 100, Zhongxing Rd., Xizhi District  
221012 New Taipei City  
TAIWAN

**Certification Mark:**



**Product:**

**Component fan  
(DC FAN)**

The product was tested on a voluntary basis and complies with the essential requirements. The certification mark shown above can be affixed on the product. It is not permitted to alter the certification mark in any way. In addition, the certification holder must not transfer the certificate to third parties. This certificate is valid until the listed date, unless it is cancelled earlier. All applicable requirements of the testing and certification regulations of TÜV SÜD Group have to be complied. For details see: [www.tuvsud.com/ps-cert](http://www.tuvsud.com/ps-cert)

**Test report no.:** 682101503003A

**Valid until:** 2027-08-07

**Date,** 2022-11-29

( Bruce Zhang )

# CERTIFICATE

No. B 118976 0002 Rev. 00

**Model(s):**

TRS2510X05L, TRS2510X05M, TRS2510X05H,  
TRS2510X12L, TRS2510X12M, TRS2510X12H,  
TRS3010X05L, TRS3010X05M, TRS3010X05H,  
TRS3010X12L, TRS3010X12M, TRS3010X12H,  
TRS3010X12VH, TRS3510X05L, TRS3510X05M,  
TRS3510X05H, TRS3510X12L, TRS3510X12M,  
TRS3510X12H, TRS4010X05L, TRS4010X05M,  
TRS4010X05H, TRS4010X05VH, TRS4010X12L,  
TRS4010X12M, TRS4010X12H, TRS4010X12VH,  
TRS4010X24M, TRS4010X24H, TRS4010X24VH,  
TRS4015X05L, TRS4015X05M, TRS4015X05H,  
TRS4015X12L, TRS4015X12M, TRS4015X12H,  
TRS4015X12VH, TRS4015X24M, TRS4015X24H,  
TRS4015X24VH, TRS4020X05D, TRS4020X05L,  
TRS4020X05M, TRS4020X12D, TRS4020X12L,  
TRS4020X12M, TRS4020X12H, TRS4020X12VH,  
TRS4020X12SH, TRS4020X24M, TRS4020X24H,  
TRS4020X24VH, TRS4020X24SH, TRD4028X12D,  
TRD4028X12L, TRD4028X12M, TRD4028X12H,  
TRD4028X12VH, TRD4028X12SH, TRD4028X24D,  
TRD4028X24L, TRD4028X24M, TRD4028X24H,  
TRD4028X24VH, TRD4028X24SH, TRS5010X05L,  
TRS5010X05M, TRS5010X05H, TRS5010X12L,  
TRS5010X12M, TRS5010X12H, TRS5010X12VH,  
TRS5010X24M, TRS5010X24H, TRS5010X24VH,  
TRS5015X05L, TRS5015X05M, TRS5015X05H,  
TRS5015X12L, TRS5015X12M, TRS5015X12H,  
TRS5015X12VH, TRS5015X24L, TRS5015X24M,  
TRS5015X24H, TRS5020X05L, TRS5020X05M,  
TRS5020X12L, TRS5020X12M, TRS5020X12H,  
TRS5020X12VH, TRS5020X24H, TRS5020X24VH,  
TRS6010X05L, TRS6010X05M, TRS6010X05H,  
TRS6010X12L, TRS6010X12M, TRS6010X12H,  
TRS6010X12VH, TRS6010X24M, TRS6010X24H,  
TRS6010X24VH, TRS6015X05D, TRS6015X05L,  
TRS6015X05M, TRS6015X12D, TRS6015X12L,  
TRS6015X12M, TRS6015X12H, TRS6015X12VH,  
TRS6015X12SH, TRS6015X24L, TRS6015X24M,  
TRS6015X24H, TRS6015X24VH, TRS6015X24SH,  
TRS6020X12D, TRS6020X12L, TRS6020X12M,  
TRS6020X12H, TRS6020X12VH, TRS6020X12SH,  
TRS6020X24L, TRS6020X24M, TRS6020X24H,  
TRS6020X24VH, TRS6020X24SH, TRS6025X12D,  
TRS6025X12L, TRS6025X12M, TRS6025X12H,  
TRS6025X12VH, TRS6025X12SH, TRS6025X24D,  
TRS6025X24L, TRS6025X24M, TRS6025X24H,  
TRS6025X24VH, TRS6025X24SH, TRD6025X12D,  
TRD6025X12L, TRD6025X12M, TRD6025X12H,  
TRD6025X12VH, TRD6025X12SH, TRD6025X24D,  
TRD6025X24L, TRD6025X24M, TRD6025X24H,  
TRD6025X24VH, TRD6025X24SH, TRD6038X12D,  
TRD6038X12L, TRD6038X12M, TRD6038X12H,



E-mail: atl@atllab.org  
Web: Http://www.atllab.org

Floor.5,Genesis Zhongye Building,No.22,  
Puzai Road,Pingdi Street,Longgang District,  
Shenzhen,Guangdong,China (518000)

# EC-Certification of Conformity

## EMC Directive 2014/30/EU

Registration No.: ATL202112071171  
 Applicant: STRIKEFAN ELECTRONIC CO.,LTD.  
 Applicant Address: 4F,NO.100,CHUNG HSIN RD.,HSICHIH DIST,NEW TAIPEI CITY,22158,TAIWAN  
 Manufacturer: STRIKEFAN ELECTRONIC CO.,LTD.  
 Manufacturer Address: 4F,NO.100,CHUNG HSIN RD.,HSICHIH DIST,NEW TAIPEI CITY,22158,TAIWAN  
 Product Designation: DC Fan  
 Brand Name: STK  
 Model / Series Models: 1238,1305,1504,1708,1804,2004,2008,2507,2512,3004,3008,4505,2010,2510,  
 3007,3010,3510,4010,4015,4510,4020,4028,5010,5015,5020,6010,6015,6020,  
 6025,6038,7010,7015,7025,7020,7032,7038,8010,8015,8020,8025,8032,8038,  
 9015,9225,9232,9238,1225,1232,1238,1338,1425,1438,14050,1551,16050,17225,  
 17238,17251,20053,20060,20070,2230,25489,3517,7530,9733,17569,12030,  
 10025,5013,15040,13840,8030,8018,3006,3015,17255,22580,28080,5025,13380,  
 17065,19067,19072,22076,22599,225101,25099,25094,200,220,250,300,2589,  
 1751

Requirement	Applied Standards	Document Evidence	Result
EMC Directive	EN IEC 61000-6-1:2019; EN 61000-6-3:2007/A1:2011/AC:2012.	Test Report: ATL202112071171E01	Conform



*Kent Zhang*  
 Signed by Quality Manager  
 Issue Date: Dec. 15, 2021

Recognized by Shenzhen ATL Testing Technology Co., Ltd., in accordance with the EMC Directive 2014/30/EU. The certificate doesn't imply assessment of the production. The Applicant of the certificate is authorized to use this certificate in connection with EC declaration of conformity to the Directive. The certificate is only applicable to the equipments described above. This certificate shall not be re-produced except in full without the written approval of Shenzhen ATL Testing Technology Co., Ltd.

Note: This certificate is part of the full test report(s) and should be used in conjunction with it.