

Cinterion® LGA DevKit Things

User Guide

Version: 02
DocId: lga_devkit_t_ug_v02

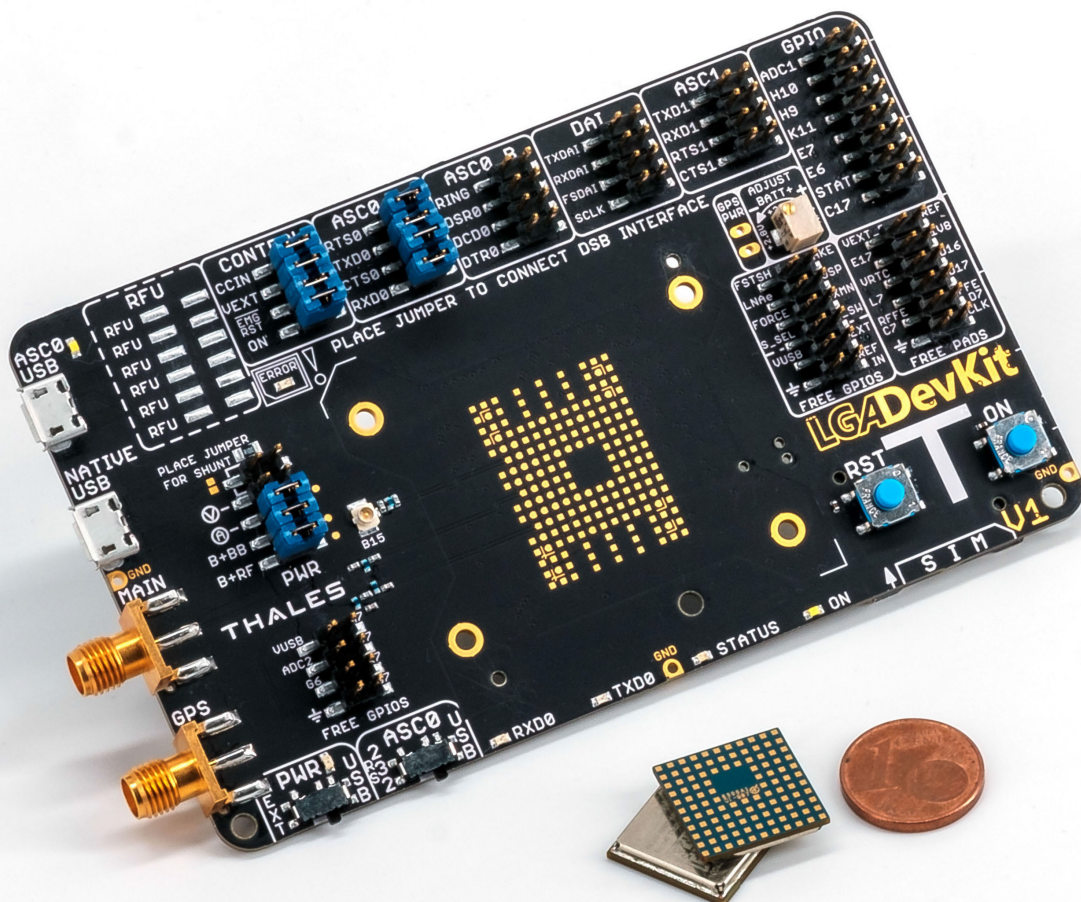

User Guide:	Cinterion® LGA DevKit Things User Guide
Version:	02
Date:	2021-01-12
DocId:	lga_devkit_t_ug_v02
Status:	Public / Released

GENERAL NOTE

THIS DOCUMENT CONTAINS INFORMATION ON THALES DIS AIS DEUTSCHLAND GMBH ("THALES") PRODUCTS. THALES RESERVES THE RIGHT TO MAKE CHANGES TO THE PRODUCTS DESCRIBED HEREIN. THE SPECIFICATIONS IN THIS DOCUMENT ARE SUBJECT TO CHANGE AT THE DISCRETION OF THALES. THE PRODUCT AND THIS DOCUMENT ARE PROVIDED ON AN "AS IS" BASIS ONLY AND MAY CONTAIN DEFICIENCIES OR INADEQUACIES. THALES DOES NOT ASSUME ANY LIABILITY FOR INFORMATION PROVIDED IN THE DOCUMENT OR ARISING OUT OF THE APPLICATION OR USE OF ANY PRODUCT DESCRIBED HEREIN.

THALES GRANTS A NON-EXCLUSIVE RIGHT TO USE THE DOCUMENT. THE RECIPIENT SHALL NOT COPY, MODIFY, DISCLOSE OR REPRODUCE THE DOCUMENT EXCEPT AS SPECIFICALLY AUTHORIZED BY THALES.

Copyright © 2021, THALES DIS AIS Deutschland GmbH

Trademark Notice

Thales, the Thales logo, are trademarks and service marks of Thales and are registered in certain countries. Microsoft and Windows are either registered trademarks or trademarks of Microsoft Corporation in the United States and/or other countries. All other registered trademarks or trademarks mentioned in this document are property of their respective owners.

Contents

1	Introduction	5
1.1	Feature and Benefits	5
1.2	Supported Products	6
1.3	Package Content	6
2	Quickstart	8
2.1	Mounting the LGA DevKit Socket	8
3	LGA DevKit Overview	9
3.1	Top and Bottom View	9
3.2	Block Diagram	10
4	LGA DevKit Interfaces	11
4.1	USB	11
4.2	SIM	11
4.3	Pin Headers	12
4.3.1	Default Configuration	12
4.4	ON Button: Module Start and Power Down	13
4.5	RST Button: Module Reset	13
4.6	ASC0 Switch: Module UART Interface Selection	13
4.7	PWR Switch: Power Source Selection	13
4.8	Free Level Shifters	14
4.9	LEDs	14
4.10	Patch Field	15
4.11	Power Supply	16
4.11.1	Supply Current Measurement	16
4.11.2	External Reference Supply	17
5	General Characteristics	18
6	Operating the LGA DevKit with a DSB	19
6.1	LGA DevKit on DSB-Mini	19
6.2	LGA DevKit on DSB75	20
7	LGA DevKit Firmware Update	21
7.1	Connect Serial Interface	21
7.2	Setup Terminal Program	22
7.3	Open Connection and Version Check	23
7.4	Update Procedure	23

8	Document Information	25
8.1	Revision History	25
8.2	Related Documents	25
8.3	Safety Precaution Notes	25
8.4	Regulatory Compliance Information.....	26
9	Appendix	27
9.1	LGA DevKit T	27
9.1.1	Placement	27
9.1.2	Schematics	28

1 Introduction

The Cinterion® LGA DevKit is designed as a generic development adapter for Cinterion® LGA modules. With the LGA DevKit it is no longer necessary to connect the Cinterion® evaluation modules to an adapter for test and development purposes.

The LGA DevKit may operate stand-alone without the need of any further tools or devices, or it can be operated with a port extender, for instance the DSB75 or DSB-Mini as an adapter between the module and further external applications.

The LGA DevKit is available in three variants:

- SM supports the complete range of industrial platform modules
- L supports most of the industrial plus platform modules
- T supports all modules of the latest Things family

This guide only refers to the T (Things) variant of the LGA DevKit. For the other two variants SM & L please refer to the corresponding User Guide ([\[3\]](#)).

The LGA DevKit T needs to be ordered together with the LGA DevKit socket T.

1.1 Feature and Benefits

- LGA DevKit socket T supports different module footprints with different LGA pad counts for the IoT (Things) platform modules: A (LGA 68), B (LGA 112), C (LGA 140)
- Future proof, ready for new, upcoming modules
- Stand-alone: Get the LGA module up and running without additional tooling
- Supports DSB75/DSB-Mini as port extender
- UART via USB VCP, and/or native USB communication
- Direct module signal access with complete interruption for deep level investigation
- Real module current consumption measurement, no additional leakage current
- Powered via USB or external devices (e.g., DSB75/DSB-Mini)
- Adjustable module supply level 2.8...4.5V
- VEXT self-adjustment for level shifter reference level
- Further supported interfaces: SPS, SIM2, ASC1, GPIO, GNSS
- Error detection: Wrong or wrongly oriented modules, as well as shorts on module, preventing damages
- Clear & easy concept for usage and signaling
- QR code scanning leads users to all the information necessary for usage

1.2 Supported Products

The following table lists modules that are supported by the LGA DevKit T, depending on the module’s pad count (i.e., module’s footprint).

Table 1: Supported products

LGA DevKit T		
A (LGA 68)	B (LGA 112)	C (LGA 140)
For future use	TX62-W	For future use

1.3 Package Content

The following package is available for the LGA DevKit. The LGA DevKit T is used with the LGA DevKit socket T:

- Cinterion® LGA DevKit T (Ordering number: L30960-N0113-A100)
 - Base PCB for the IoT platform (Things) modules
 - USB and SMA cable
 - An ultra-wideband high efficiency antenna
 - A bag of jumpers ~25pcs
 - A quick start guide
- Cinterion® LGA DevKit socket T (Ordering number: L30960-N0114-A100)
 - The needle socket fitting on PCB version for Things
 - Screws, fixing frames, retention lid

Figure 1 shows the LGA DevKit package contents, whereas Figure 2 shows how the LGA DevKit socket T can be used for the LGA DevKit T.

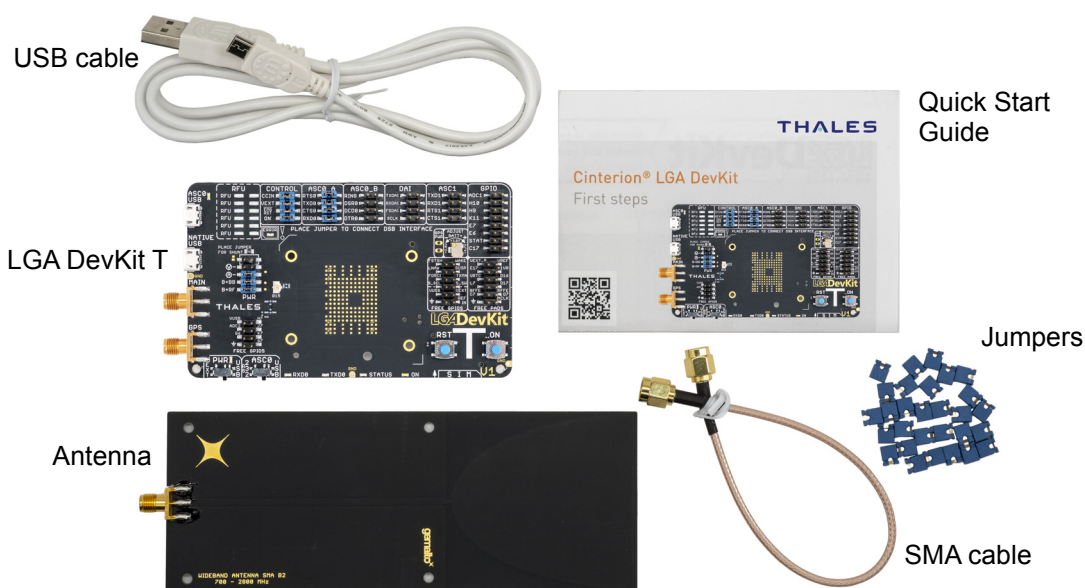

Figure 1: LGA DevKit T package content

1.3 Package Content

Cinterion® LGA DevKit socket T
(L30960-N0114-A100)

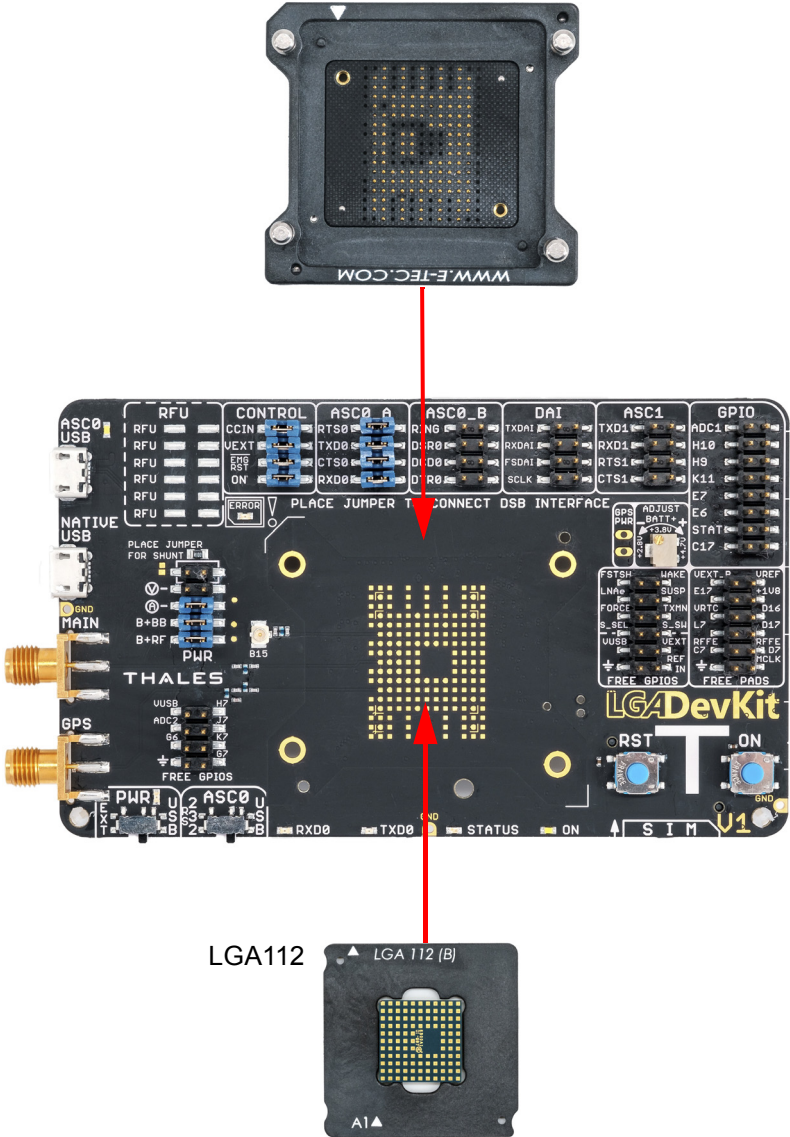

Figure 2: LGA DevKit socket T with LGA DevKit variant T

2 Quickstart

Please complete the following steps to quickly get started with your LGA DevKit.

- Mount the LGA DevKit socket onto the LGA DevKit (for details see [Section 2.1](#)).
- Insert the fixing frame and then the module into the socket and close the retention lid by pressing it down and turning it clockwise.
- Connect the provided antenna to the SMA connector named "MAIN".
- Check that the jumpers are set to their default delivery positions.
- Connect your host PC to either the USB or the USB VCP connector (depending on the module). In case of USB VCP connections, install FT232R drivers.
- Set the switches PWR & ASC0 at the DevKit's lower right corner to "USB". Now, the green "PWR" LED lights up.
- Shortly press the ON button to start the module. Now, the white "ON" LED lights up

The red "ERROR" LED may indicate issues that should be corrected. For details see [Section 4.9](#).

Note: By scanning the QR code at the underside of the LGA DevKit you will also find further information, videos and available drivers.



2.1 Mounting the LGA DevKit Socket

Before operating, the socket has to be mounted onto the LGA DevKit with 4 screws. Scanning the QR code on the DevKit's underside and/or the quick start guide will lead you to the DevKit's web home where you find a short introduction and video on how to do this.

The white printing on the DevKit shows how the socket shall be orientated and mounted. You can quickly adapt to different module footprints by using dedicated fixing frames. All contacts have low-resistivity needles.

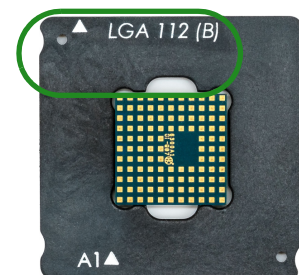

Note: The module's thermal encapsulation inside the socket increases the thermal resistance (R_{th}). Thus, you need to be aware that the board temperature may rise quite quickly until automatic thermal shutdown takes effect, especially at higher environmental temperatures or high radio output power.

3 LGA DevKit Overview

3.1 Top and Bottom View

Figure 3 and Figure 4 show the top and bottom view of the of the LGA DevKit T variant.

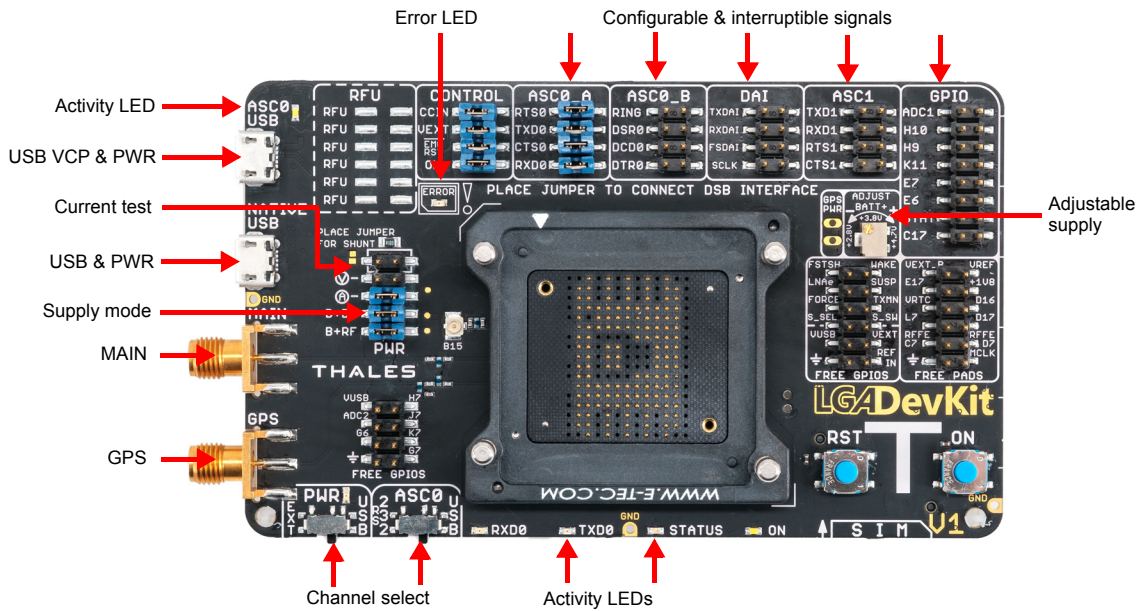

Figure 3: LGA DevKit T top view

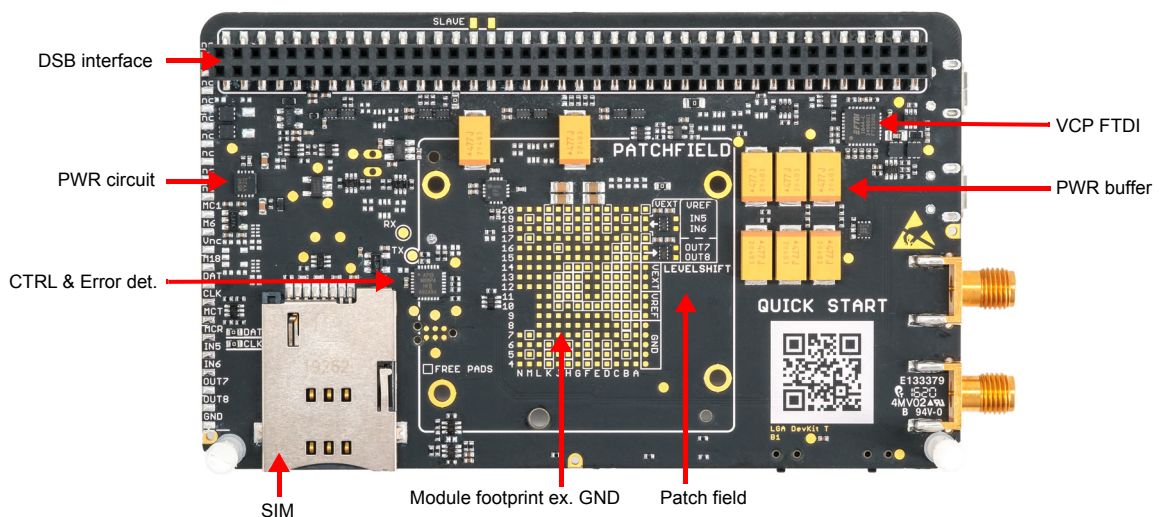

Figure 4: LGA DevKit T bottom view

3.2 Block Diagram

3.2 Block Diagram

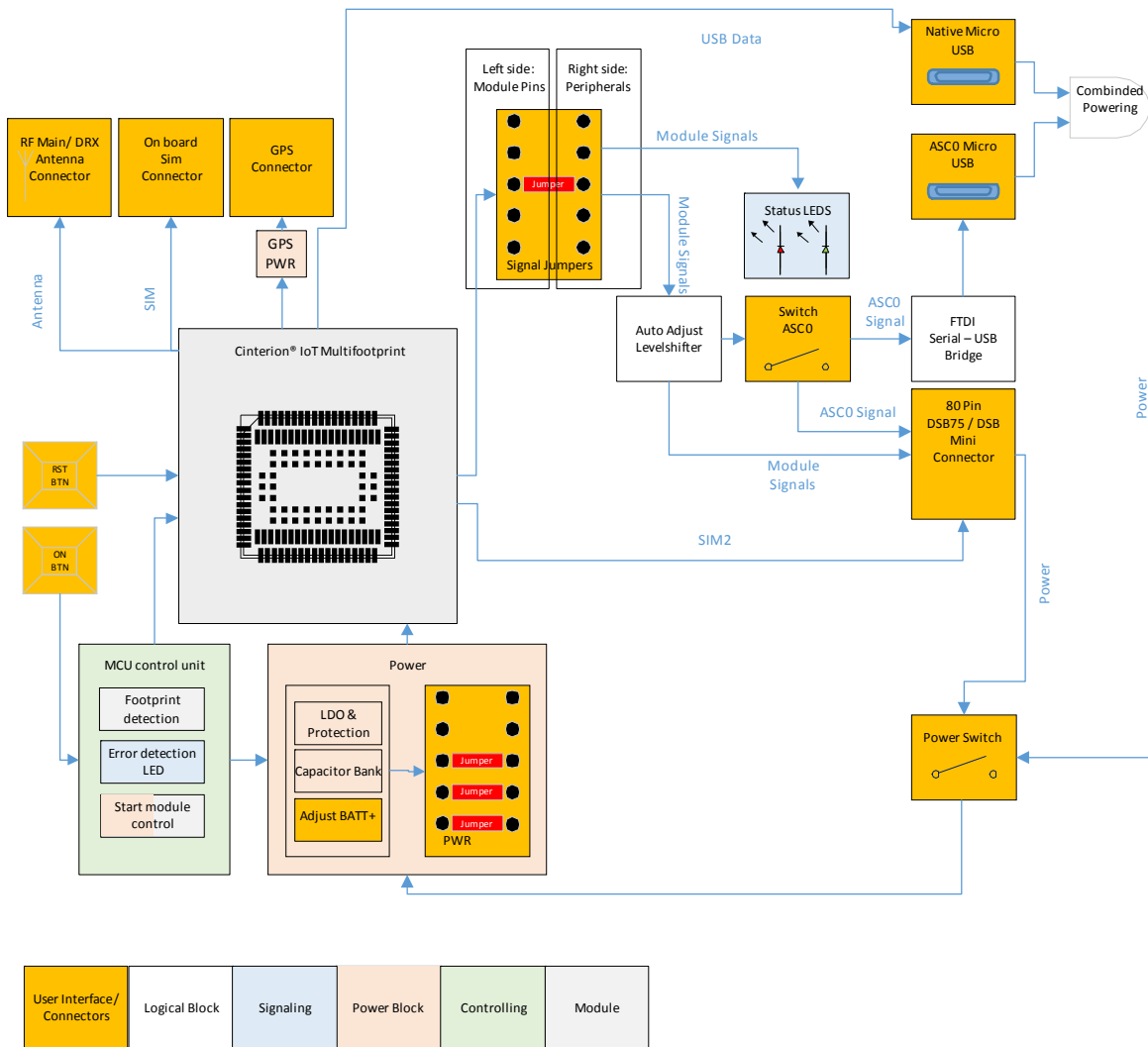

Figure 5: LGA DevKit block diagram

4 LGA DevKit Interfaces

4.1 USB

The LGA DevKit comes with two USB interfaces supporting power supply and serial communication. You may choose to setup communication via a module's USB port and/or a module's UART (ASC0) port via FTDI232R VCP.

- Both USB ports can be used in parallel while power is sourced from both ports.
- The native USB power is isolated from the VCP USB power by a diode, meaning that the VCP USB power does not feedback to the native USB power, but vice versa. This should be taken into account when supplying the LGA DevKit from different USB power sources, depending on the voltage levels there could be a power feedback from native USB to VCP USB.
- In case of marginal USB power supply both USB ports should be used to improve weak power capabilities.

Note: The modem's USB driver can be downloaded from the LGA DevKit's web page that can be reached by scanning the QR code.

4.2 SIM

On the LGA DevKit's underside you find a SIM card holder that is connected to the module's regular SIM interface lines, except for the CCIN line where the (default) jumper needs to be set for CCIN at the CONTROL pin headers (see [Section 4.3](#)). However, some modules come with an additional SIM interface. This can be accessed in conjunction with a DSB75/DSB-Mini (as port extender) to support dual SIMs - with the DSB75/DSB-Mini serving as the second SIM interface.

In case of modules with an integrated MIM, the additional SIM interface needs to be connected to the regular SIM interface using the on-board SIM switch. This switch is controlled by the signal S_SEL at the FREE GPIOs pin header. In default configuration (see [Section 4.3.1](#)) the additional SIM interface is connected to the DSB75/DSB-Mini interface. To connect an integrated MIM with the regular SIM interface the jumper needs to be set between S_SEL and S_SW (see [Figure 6](#)). Then the module's SIM switch signal SIM_SWITCH is able to control the SIM switch via AT command. Please refer to [\[1\]](#) and [\[2\]](#) for further details.

Note: If the integrated MIM is used, please ensure that there are no SIM cards inserted in the regular and additional SIM card holders.



Figure 6: SIM interfaces and switch

4.3 Pin Headers

4.3 Pin Headers

The pin headers at the top side can be used to setup connections between modules and possible on board peripherals. Thus, pin headers having signal names at their left side only, namely the pin headers CONTROL, ASC0_A, ASC0_B, DAI, ASC1, and GPIO, can be bridged by jumpers. All of these pin headers have the module's signal name on their left side (marked yellow in Figure 7), whereas the right side corresponds to peripherals like level shifters or the DSB connector (marked green in Figure 7).

- Placing a jumper connects a line through a level shifter to the associated pin at the 2x40 pin connector at the underside of the LGA DevKit (and thus to a connected DSB75/DSB-Mini). See also Figure 5.
- Not placing a jumper leaves a module signal open.

External periphery can also be connected to all accessible module signals directly. When connecting other external periphery to the pin headers pay attention not to violate the maximum module ratings.

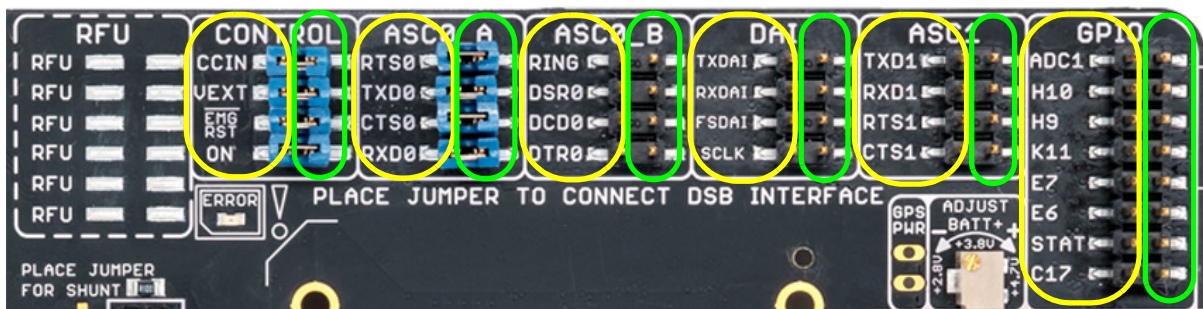

Figure 7: Pin headers

4.3.1 Default Configuration

Figure 8 shows the factory default jumper and switch positioning.

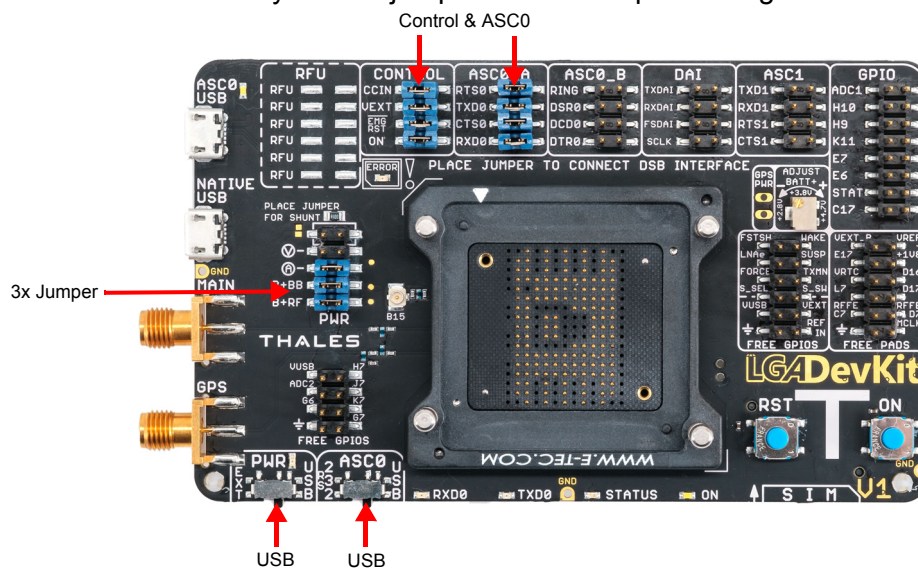

Figure 8: Default jumper and switch configuration

4.4 ON Button: Module Start and Power Down

Pushing the ON button shortly (i.e., <0.5s), the LGA DevKit starts up and initially analyses the mounted module orientation and type. In case both are recognized and correct, the module is started using specific start pulses. The white LED indicates the module's VEXT state as high.

Also, it is possible to start up the module by toggling DTR on the DSB75/DSB-Mini RS232 connector.

Pushing the ON button for more than 2s shuts down the LGA DevKit's power supply, and the module's power supply is interrupted regardless of its current state.

4.5 RST Button: Module Reset

Pushing the RST button pulls down a module's EMERG-RST/OFF signal, thus forcing it into reset or off state. Please note that this functionality is only available if the (default) jumper is set for EMERG_RST at the CONTROL pin block (see [Section 4.3](#)).

4.6 ASC0 Switch: Module UART Interface Selection

The "ASC0" switch selects the module's UART communication interface either via USB VCP (FTDI232R) or via "RS232" D-Sub interface on the DSB75/DSB-Mini.

Changing this from "USB" to "RS232" during operation resets the FTDI VCP bridge in order to release the signal lines, thus leading to a USB VCP disconnect on the host PC side.

4.7 PWR Switch: Power Source Selection

The "PWR" switch selects the preferred power source, both sources can be connected at the same time, but do not supply the LGA DevKit in parallel.

When "USB" is set, both LGA DevKit USB ports will contribute to the overall power supply with a connected DSB75/DSB-Mini having to be powered separately. Setting "EXT", the power is supplied from the DSB75/DSB-Mini interface.

Please note that there is a dedicated power supply for the GPS antenna. To use this, the two pins at the GPS_PWR field will have to be soldered and connected by jumper.

4.8 Free Level Shifters

The LGA DevKit provides 4 free level shifters, placed & connected at the patch field on the underside. The level shifters are referenced to the module's Vext, and Vref that by default corresponds to 3V or to "REF IN" if connected (see [Section 4.11.2](#)). The Vref related level shifter connections can also be accessed via four additional pads at the left underside of the LGA DevKit where additional pins may be soldered.

These level shifters can be used to shift signals that are not available at the DSB connector.

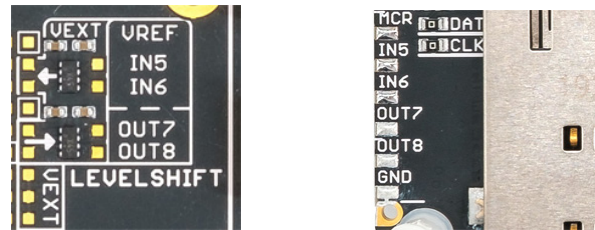

Figure 9: Four Level shifters (@patch field or @left edge)

4.9 LEDs

The LGA DevKit LEDs have the following meaning:

LED	Meaning
RED	Blinking continuously: Module is inserted wrongly oriented, not powered, insert correctly Blinking 2 times: No module inserted, not powered Blinking 3 times: A module not supported by footprint is inserted, not powered, change module Lighting: Overcurrent detected in module power path, change module, restart LGA DevKit's power supply
GREEN	Module TXD0 activity, low active
GREEN PWR	Sufficient supply level, but not switched on
AMBER	Module RXD0 activity, low active
BLUE	Module state GPIO5 / LED (if a jumper is set for GPIO5 at the GPIO pin headers)
WHITE ON	Module started, V180/300 is at high level (if the (default) jumper is set for VEXT at the CONTROL block)
WHITE USB	TX/RX activity on USB VCP

4.10 Patch Field

A small patch field is available at the LGA DevKit's underside. If required, you can add simple components (LED, Transistors etc.) here. All module signals, except USB and RF are accessible at the underside by the labeled pads.

4 level shifters are accessible close to the patch field as well with the reference Vext and Vref. The Vref related level shifter connections can also be accessed via four additional pads at the left underside of the LGA DevKit where additional pins may be soldered (see [Figure 9](#)).

Attention: The warranty may be lost if the patch field is soldered.

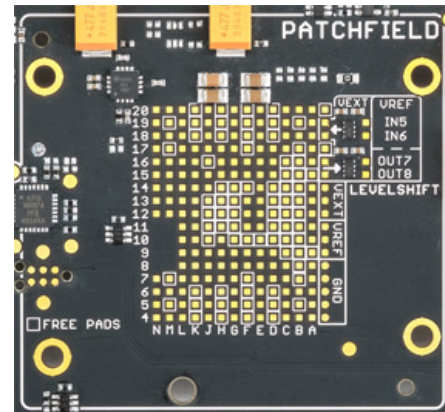

Figure 10: Patch field

4.11 Power Supply

The LGA DevKit can be supplied through one or two USB ports that should be in the range of 5V +-5%, and/or externally by the DSB75/DSB-Mini. The modules supply level can be adjusted in the range between 2.8...4.8V by setting the variable resistor at the DevKit's top side. The DevKit power supply path is short protected with ~2A. In case of overcurrent the power path will be interrupted and the red LED lights up until the power has been reset.

As a recommendation the LGA DevKit should be supplied with 5V/1A over one or two USB ports. The onboard bypass capacitors should buffer enough energy to support short 2G peak currents up to 2.5A.

4.11.1 Supply Current Measurement

The LGA DevKit supports three methods to measure the current consumption of the inserted module.

- Measure the voltage across the on board 100 mOhm shunt resistor
- Measure the current by a current meter
- Power the module by an external power supply e.g. power analyzer

All options require a jumper placed on the 4th "BB" and 5th "RF" row for connecting baseband and radio. Those two jumpers also allow to measure the current separately for the BB and RF path.

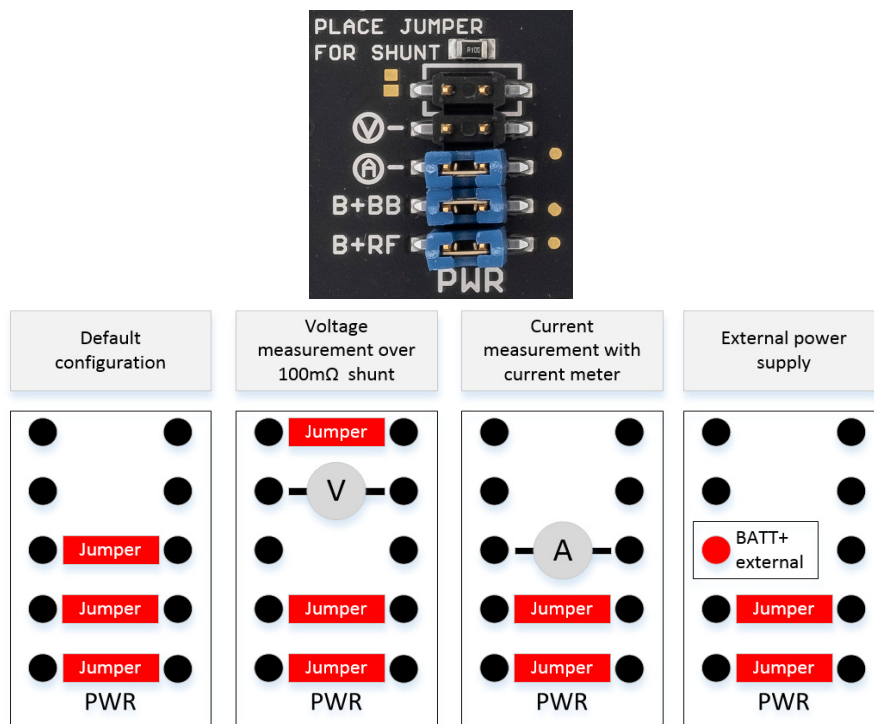

Figure 11: Supply current measurements

Note: When measuring with a current meter, the meter's internal resistance may cause a high voltage drop, forcing the module to shut down. This can be avoided by measuring the voltage across the shunt. The current option is suitable for specialist power meter supplies, whereas the voltage option is suitable for common voltage meters.

4.11.2 External Reference Supply

To drive/operate the LGA DevKit's interfaces at certain voltage levels, an external reference voltage may be connected. By default, i.e., without an external reference voltage connected, the interface operates at 3V to meet the DSB75/DSB-Mini requirements. But if it is required to operate the interface at another voltage, an external source in the range between 1.2V...5V can be connected to "REF IN" and "GND" as shown in [Figure 12](#).



Figure 12: External reference supply and pin header for free level shifter

Please note that this jumper should not be set when the LGA DevKit is connected to a DSB.

5 General Characteristics

The following table lists absolute maximum ratings for the LGA DevKit. Please note that violation of these limits may cause permanent damage to the LGA DevKit.

Table 2: Absolute maximum ratings

Parameter	Min	Max	Unit
Voltage on USB ports	-0.3	5.5	V
Voltage on DSB port	-0.3	5.5	V
Voltage on signal pin header, depending on used module	-0.3	2.1	V
Current signal pin header, depending on used module	-10	+10	mA
Voltage on external reference	-0.3	6	V
Socket single contact continues current		2	A

The following table lists recommended operating and environmental conditions for the LGA DevKit.

Table 3: Operating and environmental conditions

Parameter	Min	Max	Unit
Recommended operating condition	0	45	°C
Storage temperature	0	85	°C
Supply voltage on USB port	4.75	5.25	V
Supply current capability on USB port	1		A
Socket single contact resistance (Rev1)	80	120	mOhm
Socket single contact resistance (Rev1.1)	25	35	mOhm
Socket spring life cycle		100,000	

6 Operating the LGA DevKit with a DSB

6.1 LGA DevKit on DSB-Mini

The LGA DevKit supports a 2x40pin connector at its underside, compatible to the DSB75/DSB-Mini. A DSB may be a port extender for an RS232 interface, a second SIM or an analog audio interface. When operating the LGA DevKit with a DSB the following settings can be adjusted.

- Use the "PWR" switch to select the power source. If you select "EXT", the DevKit expects the power on the DSB connector. If you select "USB", the DevKit is powered by its USB ports, and the DSB expects a separated power source.
- Use the "ASC0" switch to select the first UART. If you select "RS232", the modules ASC0 is conducted to the DSB and can be accessed on the D-SUB connector. If you select "USB" the UART can be accessed via USB VCP port

Note that the USB VCP bridge will be in reset state while "RS232" is activated. As a consequence the interface is de-enumerated on host side.

Also note that in order to reliably switch between the USB VCP bridge and the RS232 interface, the DSB Mini requires an additional 47k pull up resistor. See red box in [Figure 13](#) for placement.

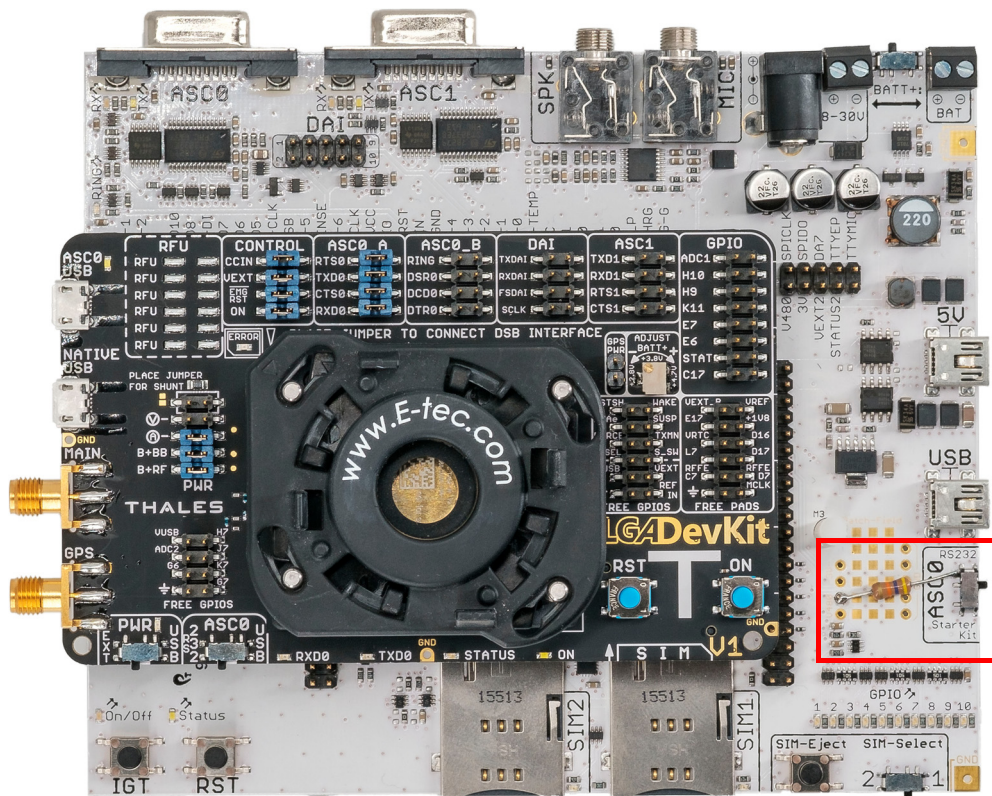

Figure 13: LGA DevKit on DSB-Mini

6.2 LGA DevKit on DSB75

To operate the LGA DevKit with the DSB75 please complete the following steps:

- Mount the LGA DevKit onto the DSB75.
- Insert the module.
- Set "PWR" and "ASC0".
- Check if all jumpers are placed at the pin header: CONTROL, ASC0_A and PWR
- Connect the host PC to DSB75 via Sub-D.
- Connect power to DSB75 and if needed to the LGA DevKit.
- Press the ON button (or the DSB75 IGT button).

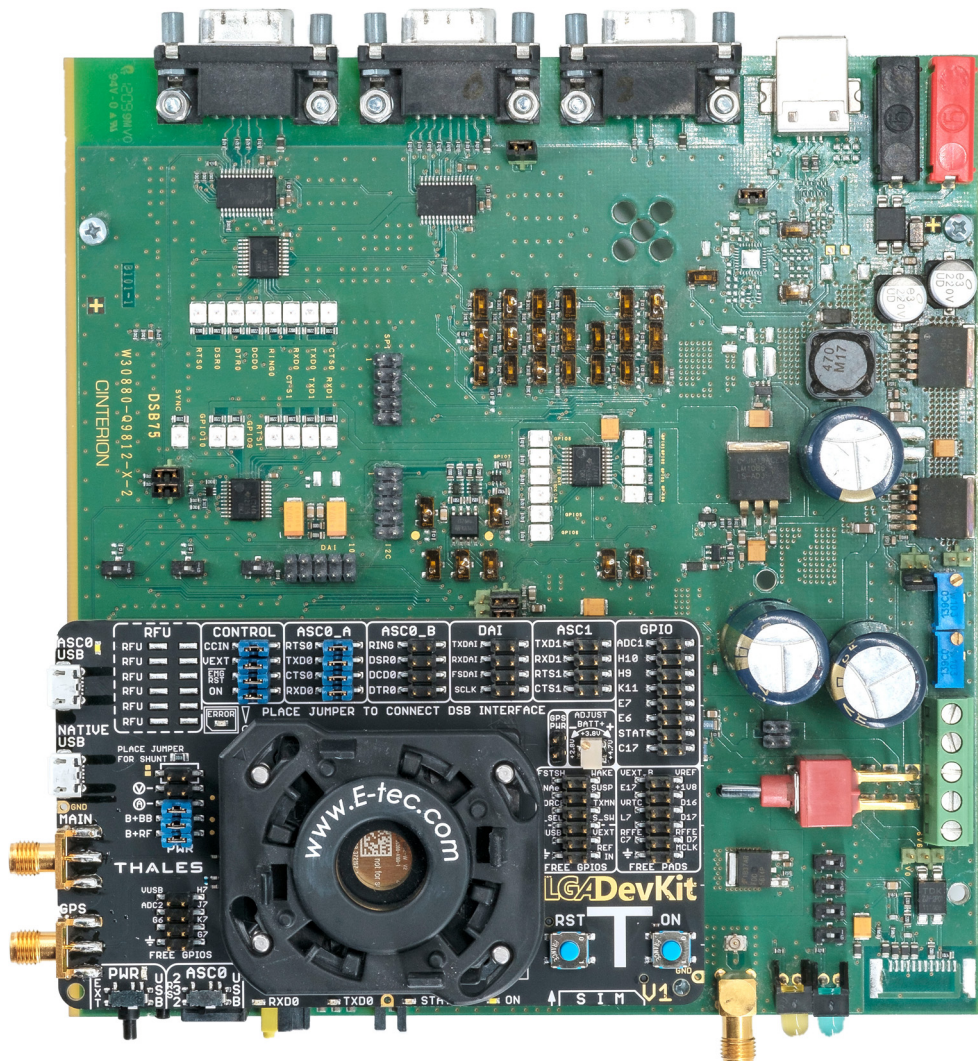

Figure 14: LGA DevKit on DSB75

7 LGA DevKit Firmware Update

The Cinterion® LGA DevKit features an internal processing unit that operates the LGA DevKit as well as the mounted modules - to for instance prevent damage when a module is inserted wrongly.

The processing unit's firmware may have to be updated from time to time in order to be compatible with newer modules. Please get in touch with Thales for the latest firmware.

This chapter guides you step-by-step through the firmware update process for your Cinterion® LGA DevKit via serial interface.

7.1 Connect Serial Interface

The first step connects the appropriate serial interface. On the LGA DevKit's bottom side find the two serial interface test points RX and TX as marked in [Figure 15](#).

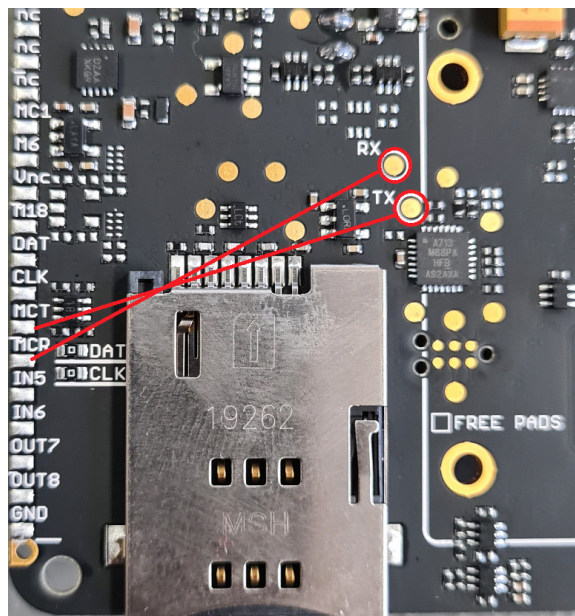

Figure 15: Connect RX/TX test points, or MCR/MCT pads

Solder jumper wires to the RX and TX test points, or a pin header to MCT (TX) and MCR (RX) pads, and use an FTDI 3.3V cable, e.g., TTL-232RG-VSW3V3-WE or any 3.3V RS232/TTL converter, to connect RX (Receive from LGA DevKit) and TX (Transmit from LGA DevKit).

7.2 Setup Terminal Program

The second step configures a terminal program to connect to the LGA DevKit. Open a terminal program (the below example uses ZOC and Tera Term).

The following terminal settings are required:

- COM Port -> chose the FTDI VCP under your device manager (in this example COM19)
- Choose 9600 baud with 8N1
- Disable RTS/CTS
- Xon/Xoff handshake on

Note: The transmit delay between every character in TeraTerm should be set to be >1ms/char and 50ms/line. By default ZoC uses a default setting of 50ms/line. In case of an upload error the char transmit buffer should be set to 1ms/char under the tab *File transfer*.

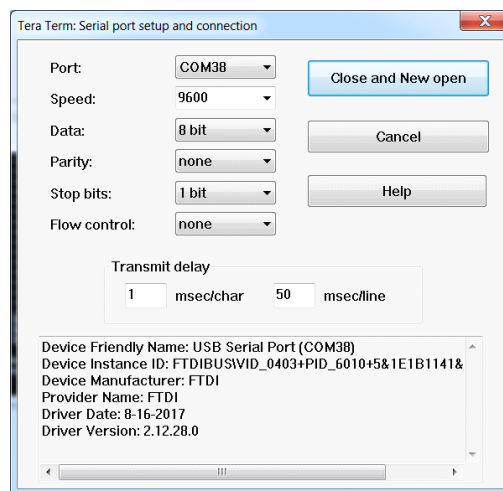
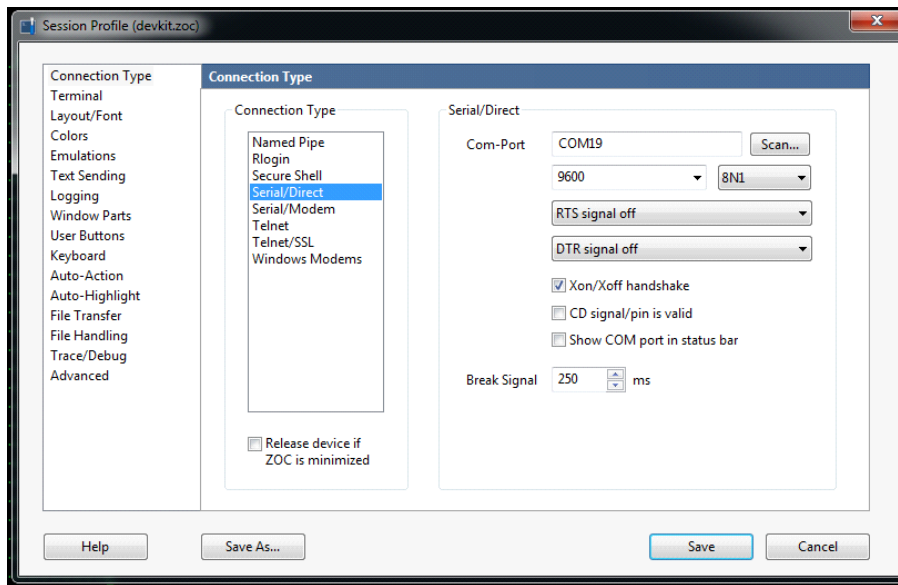

Figure 16: Setup terminal program

7.3 Open Connection and Version Check

The third step opens a connection to the Cinterion® LGA DevKit to check the current firmware version. Open the channel by clicking on "Save".

Now, after powering on the LGA DevKit by simply connecting a USB cable the firmware version should be issued. e.g.,

```
LGA DevKit Bootloader: v1.0.0
LGA DevKit Bootloader: Press ON for Programming Mode
LGA DevKit Bootloader: booting firmware

TX DevKit A1
Firmware Version: 1.0.0
```

7.4 Update Procedure

After having checked the firmware currently running on the Cinterion® LGA DevKit, the fourth and final step completes the update process.

- Bring the LGA DevKit into bootloader mode by:
 - Disconnecting the USB cable from the LGA DevKit (removing the power source)
 - Pressing the ON button continuously and re-plug the USB cable
 - The LGA DevKit now indicates a programming mode by flashing a red LED on its top.
- The LGA DevKit is now ready to receive the update *.hex file as new firmware.

```
LGA DevKit Bootloader: v1.0.0
LGA DevKit Bootloader: Programming mode
LGA DevKit Bootloader: Ready for receiving application .hex file
```

- Open the *.hex firmware with an editor, e.g., Notepad. Mark the complete text and copy it.

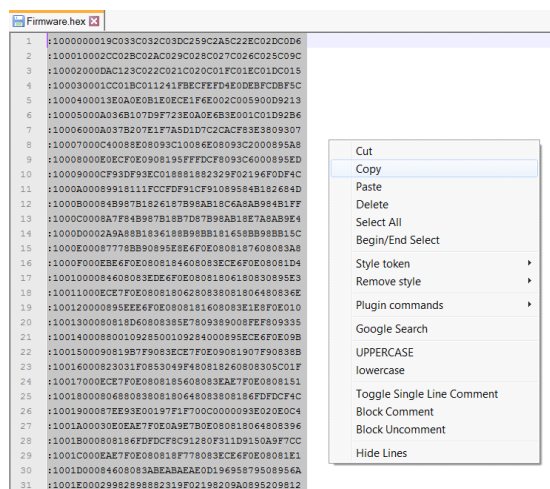

Figure 17: Copy update *.hex file

7.4 Update Procedure

- Paste the text/firmware into your ZOC or Tera Term terminal.

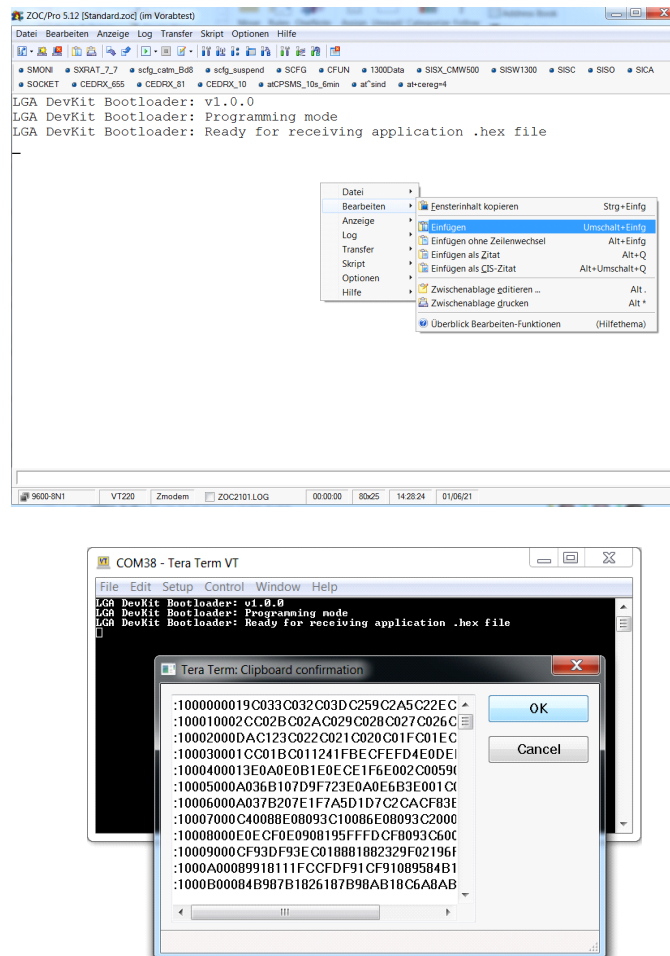

Figure 18: Paste update *.hex file

- Now, you can view the update progress over the connected interface. Finally, the output shows that the new firmware is booting up and displays the new firmware revision string.

```

... more lines in between...

LGA DevKit Bootloader: Press ON for Programming Mode
LGA DevKit Bootloader: booting firmware

TX DevKit A1
Firmware Version: 1.0.1
    
```

We recommend you to use the ZOC or Tera Term terminal and follow the instructions. With other terminal programs \n \r or spaces during the update process might corrupt the firmware.

In that case you will see a CRC Error and need to repeat the update with the correct settings.

8 Document Information

8.1 Revision History

Preceding document: "Cinterion® LGA DevKit Things User Guide" v0

New document: "Cinterion® LGA DevKit Things User Guide" v02

Chapter	What is new
7	New chapter LGA DevKit Firmware Update .

New document: "Cinterion® LGA DevKit Things User Guide" v01

Chapter	What is new
---	Initial document setup.







8.2 Related Documents

- [1] Hardware Interface Description for your Thales module
- [2] AT Command Set for your Thales module
- [3] Cinterion® LGA DevKit User Guide (SM and L)

8.3 Safety Precaution Notes

The common safety precautions that apply to mobile phones must also be observed at all times when using this LGA DevKit T. Failure to comply with these precautions violates safety standards. Thales assumes no liability for customer's failure to comply with these precautions.

The following is a non-extensive list of the mobile phone and LGA DevKit T usage restrictions:

	Pacemaker patients are advised to keep their hand-held mobile away from the pacemaker while it is on.
	Mobile phones must be switched off before boarding an aircraft.
	Mobile phones may not be operated in the presence of flammable gases or fumes
	Interference can occur if mobile phones are used close to TV sets, radios, computers or inadequately shielded equipment
	Do not use your mobile while driving a vehicle
	You should never rely solely upon any wireless device for essential communications, for example for emergency calls

The power supply connected to the LGA DevKit T shall be in compliance with the SELV requirements defined in EN 60950-1.

8.4 Regulatory Compliance Information

The Cinterion® LGA DevKit is intended for evaluation and development purposes only, and should therefore only be used in a (laboratory) test environment. The device is not CE approved, and has not been authorized as required by the rules of the FCC. All persons handling the Cinterion® LGA DevKit must be properly trained in electronics and observe good engineering practice standards.

9 Appendix

9.1 LGA DevKit T

9.1.1 Placement

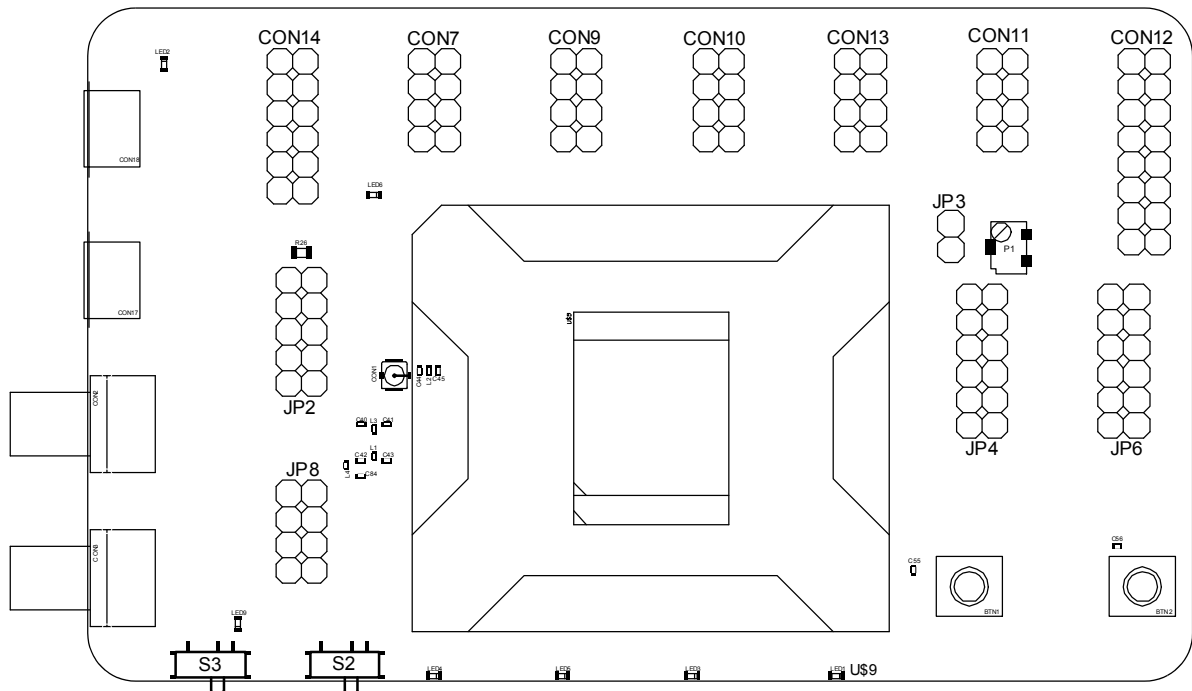

Top view

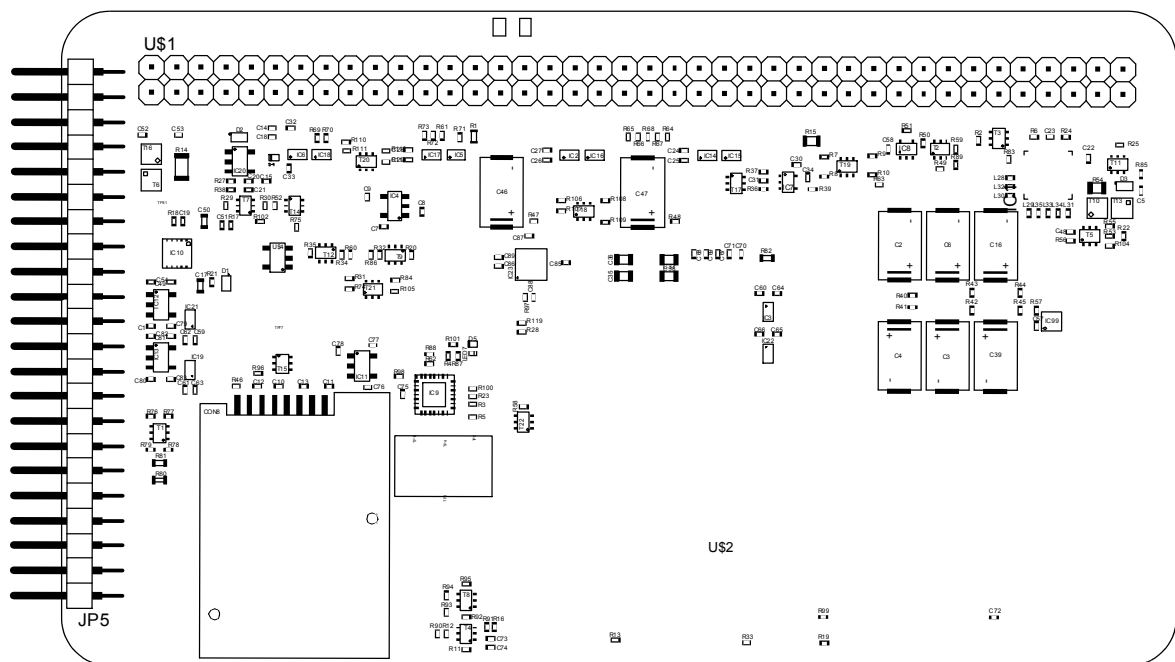

Underside view

Figure 19: Top and bottom placements (LGA DevKit T)

9.1 LGA DevKit T

9.1.2 Schematics

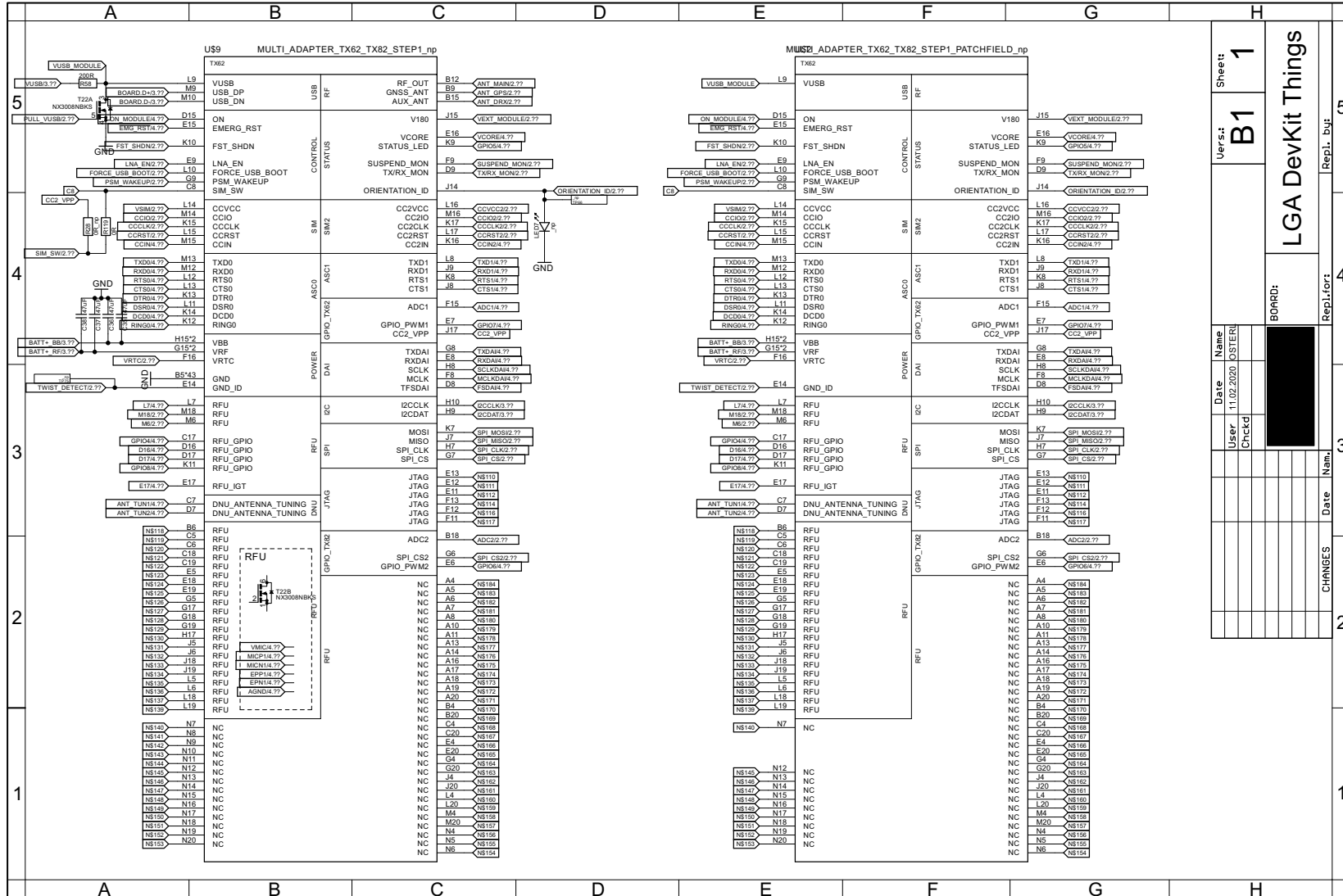

Sheet:	B1
Version:	1
Date:	11.02.2020
User:	OSTER
Checked:	[Redacted]
Name:	LGA DevKit Things
Date:	
Changes:	

9.1 LGA DevKit T

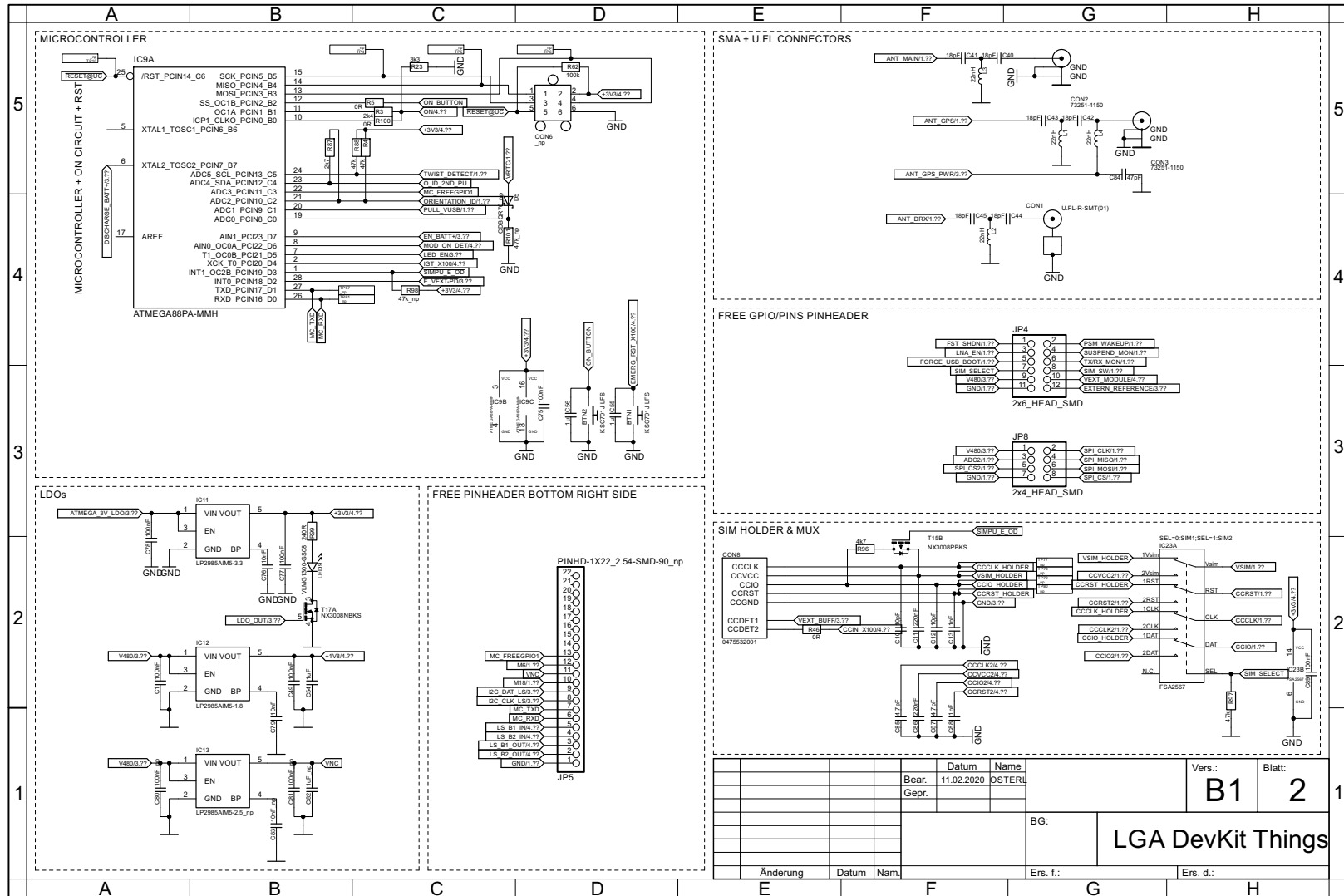

9.1 LGA DevKit T

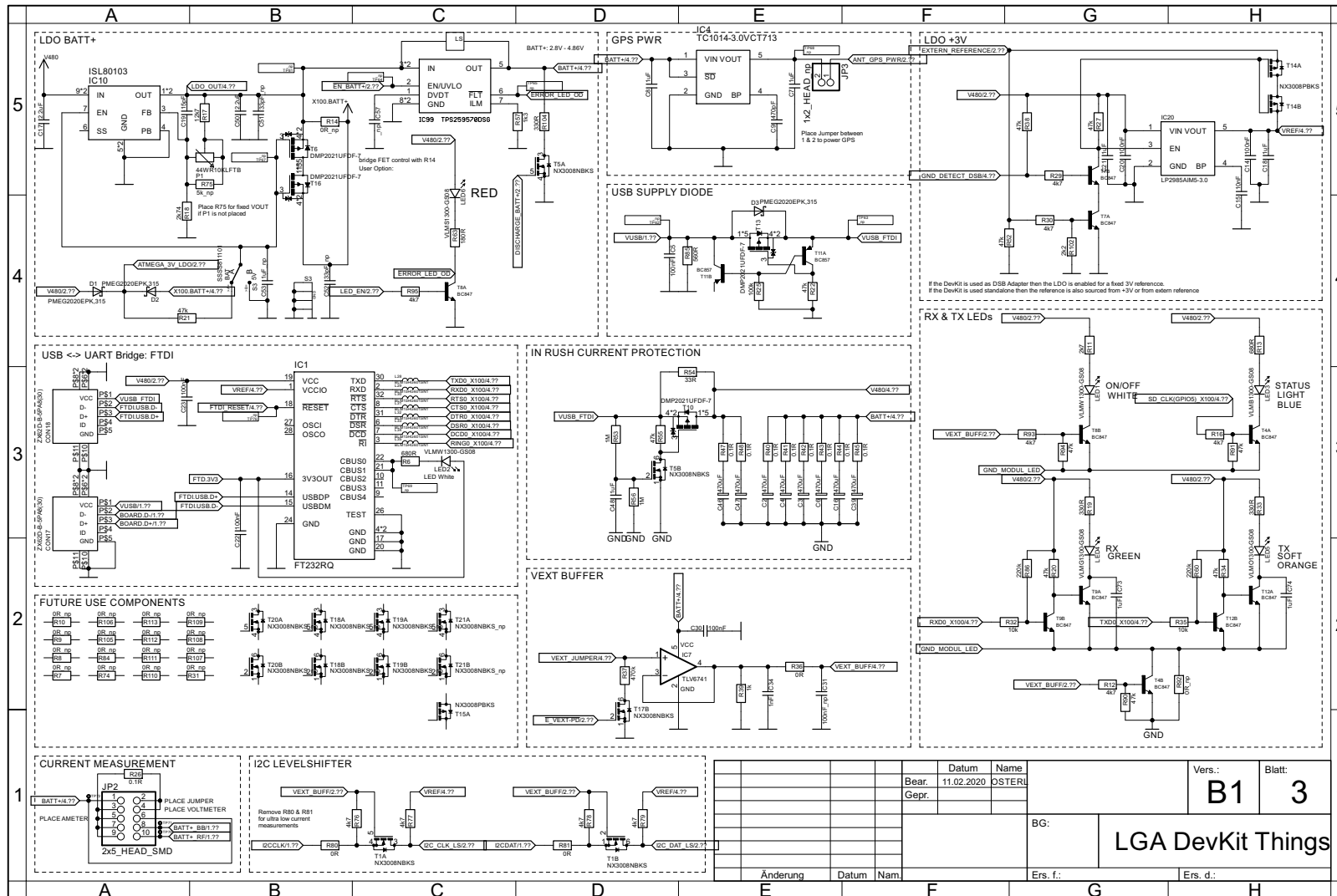

9.1 LGA DevKit T

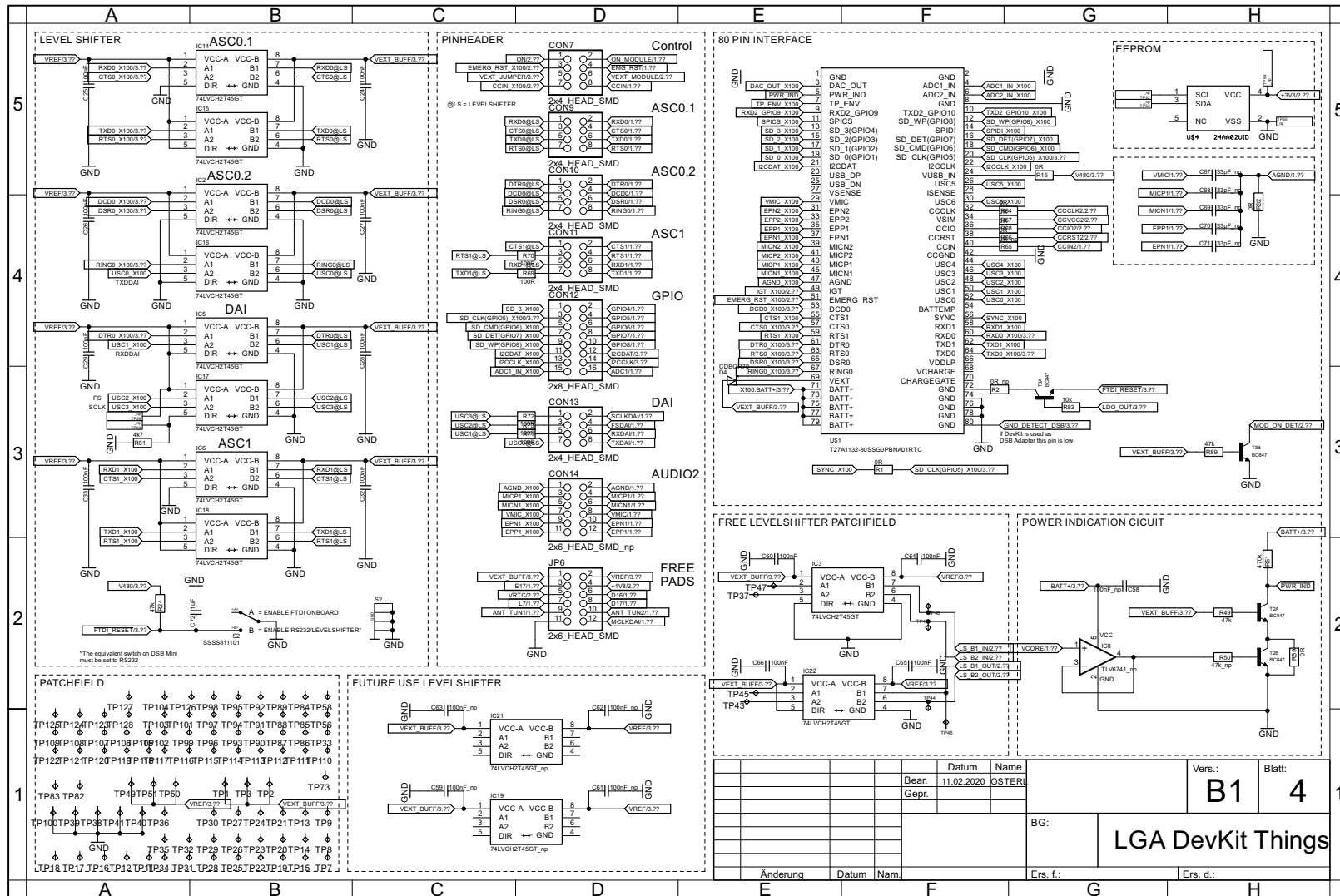



THALES DIS AIS Deutschland GmbH
Werinherstrasse 81
81541 Munich
Germany

THALES